

# LXC31X0/LXC39X0

## Series Genset Controller

LXC31X0/LXC39X0 User Manual

Ver1.3 Date: 2015/03/19



### LXC31X0/LXC39X0 Series



### Software version

Date	Versio	Note
2012-06-12	1.0	Original release.
2014-12-26	1.1	Flywheel teeth configuration items increase: (When genset has no magnetic sensor, please set to 5 to close magnetic sensor)
2015-02-09	1.2	Add LXC39X0 introduction
2015-03-19	1.3	Application picture updated

**Clarification of notation used within this publication.**

Symbol	Instruction
 NOTE	Highlights an essential element of a procedure to ensure correctness.
 CAUTION	Indicates a procedure or practice, which, if not strictly observed, could result in damage or destruction of equipment.
 WARNING	Indicates a procedure or practice, which could result in injury to personnel or loss of life if not followed correctly.

## Contents

1. Summary.....	4
2. Performance and characteristics.....	4
3. Specification.....	5
4. Operation.....	6
4.1. Push buttons.....	6
4.2. Indicator light.....	7
4.3. Automatic start/stop operation.....	8
4.3.1. Auto Start Sequence,.....	8
4.3.2. Auto Stop Sequence,.....	8
4.4. Manual start/stop operation.....	9
5. Protection.....	9
5.1. Warnings.....	9
5.2. Shutdown alarm.....	10
6. Connections.....	11
7. Parameters setting.....	13
7.1. Password Management.....	13
7.2. Language.....	14
7.3. Mode Select.....	14
7.4. Definition and range of parameters.....	14
7.5. Programmable input 1-4 table (Active when connect GND (B-)).....	19
7.6. Programmable output 1-5.....	20
7.7. Sensor select.....	22
7.8. Conditions of crank disconnect.....	22
7.9. Sensor select.....	23
7.10. Sensor unit conversion table.....	24
8. Commissioning.....	24
9. Typical application.....	25
10. Installation.....	26
10.1. Fixing clips.....	26
10.2. Overall dimension and panel cutout.....	27
11. Fault finding.....	28
12. Product packaging.....	28











Programmable Relay Output 5	5A AC250V voltage-free output
Overall Dimensions	143mm x 115mm x41mm
Panel Cutout	110mm x 90mm
CT Secondary Current	5A (rated)
Working Condition	Temperature: (-25~70)°C; Humidity: (20~93)%RH
Storage Condition	Temperature: (-25~70)°C
Protection Level	IP55:When waterproof rubber seal installed between the controller and panel fascia. IP42:When waterproof rubber seal is not installed between the controller and panel fascia.
Insulation Intensity	Object: input/output/power Quote standard: IEC688-1992 Test way: AC1.5kV/1min leakage current:3mA
Weight	330g

## 4. Operation

### 4.1. Push buttons

	Stop/ Reset	Stop running generator in Auto/Manual mode; In case of alarm condition, pressing the button will reset alarm; During stopping process, press this button again to stop generator immediately; In Standby mode, pressing and holding the button for 3 seconds will test indicator lights (lamp test).
	Start	Start genset in Manual/Test mode.
	Manual	Pressing this key will set the module into manual mode.
	Automatic	Pressing this key will set the module into auto mode.
	Set/Confirm	Pressing this key will enter into Main Menu; In setting parameter status, press this key will shift cursor or confirm setting value.
	Up/Increase	Scrolls the screen up; Shift the cursor up or increase the set value in parameter setting menu.
	Down/Decrease	Scrolls the screen down; Shift the cursor down or decrease the set value in parameter setting menu.

## 4.2. Indicator light

### LXC3110/LXC3910 Panel Indicators



### LXC3120/LXC3920 Panel Indicators



### 4.3. Automatic start/stop operation

Auto mode is selected by pressing the  button; a LED besides the button will illuminate to confirm the operation.

#### 4.3.1. Auto Start Sequence,







- ❖ LXC3X20: When mains is abnormal (over/under voltage, loss of phase), enter into “Mains Abnormal Delay” and LCD displays count down time. When the delay is over, “Start Delay” timer is initiated.
- ❖ LXC3X10: When “Remote Start” is active, “Start Delay” timer is initiated.
- ❖ “Start Delay” countdown will be displayed on LCD.
- ❖ When start delay is over, preheat relay energizes (if configured), “preheat delay XXs” information will be displayed on LCD.
- ❖ After the above delay, the Fuel Relay is energized, and then one second later, the Start Relay is engaged. The engine is cranked for a pre-set time. If the engine fails to fire during this cranking attempt then the fuel relay and start relay are disengaged for the pre-set rest period; “crank rest time” begins and wait for the next crank attempt.
- ❖ Should this start sequence continue beyond the set number of attempts, the start sequence will be terminated, the first line of LCD display will be highlighted with black and Fail to Start fault will be displayed.
- ❖ In case of successful crank attempt, the “Safety On” timer is activated, allowing Low Oil Pressure, High Temperature, Under speed, Charge Alternator Failure and Aux. inputs (configured) to stabilize without triggering the fault. As soon as this delay is over, “start idle” delay is initiated (if configured).
- ❖ During “start idle” delay, under speed, under frequency, under voltage alarms are inhibited. When this delay is over, “warming up” delay is initiated (if configured).
- ❖ After the “warming up” delay, if generator status is normal, its indicator will be illuminated. If generator voltage and frequency have reached on-load requirements, then the generator close relay will be energized; genset will take load; generator power indicator will illuminate and generator will enter into Normal Running status. if voltage or frequency is abnormal, the controller will initiate shutdown alarm (alarm information will be displayed on LCD).

#### 4.3.2. Auto Stop Sequence,

- ❖ LXC3X20: During normal running process, if mains normal, enters into “Mains Normal Delay”. When mains indicator illuminates, “Stop Delay” begins.
- ❖ LXC3X10: When the “Remote Start” signal is removed, the stop delay is initiated.
- ❖ Once this “stop delay” has expired, the Generator Breaker will open and the “Cooling Delay” is then initiated. After “Transfer Delay”, the mains close relay will be energized; mains will take load; generator power indicator will extinguish while mains power indicator will illuminate.
- ❖ During “Stop Idle” Delay (if configured), idle relay is energized.
- ❖ “ETS Solenoid Hold” begins, ETS relay is energized while fuel relay is de-energized.
- ❖ “Fail to Stop Delay” begins, complete stop is detected automatically.
- ❖ Generator is placed into its standby mode after its complete stop. Otherwise, fail to stop alarm is initiated and the corresponding alarm information is displayed on LCD.



## 4.4. Manual start/stop operation

- ❖ LXC3X20: Manual mode is selected by pressing the  button; a LED besides the button will illuminate to confirm the operation.
- ❖ Press  key, select “Mode Select”, then choose “Test Mode”. Under the two modes, press  button to start the genset, it can automatically judge crank success and accelerate to high speed running. If high temperature, low oil pressure, over speed and abnormal voltage occur during genset running, controller can effectively protect genset to stop. Under Manual Mode, if mains normal, load breaker won't transfer; if mains abnormal, load breaker will transfer to generator. Under Test Mode, after genset high speed normal running, no matter mains normal or not, load will be transferred to generator.
- ❖ LXC3X10: Manual mode is selected by pressing the  button; a LED besides the button will illuminate to confirm the operation; Then press  button to start the generator, it can automatically judge crank success and accelerate to high speed running. If high temperature, low oil pressure, over speed and abnormal voltage occur during genset running, controller can effectively protect genset to stop. After genset high speed normal running, controller will send Gen Closed signal.
- ❖ Manual stop: pressing  key can shut down the running genset.

## 5. Protection

### 5.1. Warnings

When controller detects the warning signal, only alarm and not lead to shutdown. The alarm information will be displayed on LCD.

Warnings types are as follows:

No.	Items	Description
1	High Temperature	When the controller detects that engine temperature has exceeded the pre-set value while shutdown is prohibited, or detects that the Aux. input high temperature while shutdown is prohibited, it will initiate a warning alarm and the corresponding alarm information will be displayed on LCD.
2	Low Oil Pressure	When the controller detects that the oil pressure has fallen below the pre-set value while shutdown is prohibited, or detects that the Aux. input low oil pressure while shutdown is prohibited, it will initiate a warning alarm and the corresponding alarm information will be displayed on LCD.
3	Gen Over Current	When the controller detects that the genset current has exceeded the pre-set value and the over current delay has expired, it will initiate a warning alarm and the corresponding alarm information will be displayed on LCD.
4	Fail To Stop	After “fail to stop” delay/ ETS delay, if gen-set does not stop completely, it will initiate a warning alarm and the corresponding alarm information will be displayed on LCD.
5	Low Fuel Level	When the controller detects that the fuel level has fallen below the pre-set value while shutdown is prohibited, or detects that the Aux. input low fuel level while shutdown is prohibited, it will initiate a warning alarm and the corresponding alarm information will be displayed on LCD.
6	Charge Alt Failure	When the controller detects that charger voltage has fallen below the pre-set value, it will initiate a warning alarm and the corresponding alarm information will be displayed on LCD.

7	Battery Under Volt	When the controller detects that battery voltage has fallen below the pre-set value, it will initiate a warning alarm and the corresponding alarm information will be displayed on LCD.
8	Battery Over Volt	When the controller detects that battery voltage has exceeded the pre-set value, it will initiate a warning alarm and the corresponding alarm information will be displayed on LCD.
9	Auxiliary Input	When the controller detects that the auxiliary input warning signals, it will initiate a warning alarm and the corresponding alarm information will be displayed on LCD.
10	Loss Of Speed Signal	When the controller detects that the engine speed is 0 and the delay is 0, it will initiate a warning alarm and the corresponding alarm information will be displayed on LCD.
11	Low Coolant Level	When the controller detects the low coolant level input is active, it will initiate a warning alarm and the corresponding alarm information will be displayed on LCD.
12	Temp. Sensor Open	When the controller detects that the temperature sensor is open circuit and the action select "Warn", it will initiate a warning alarm and the corresponding alarm information will be displayed on LCD.
13	Oil Pressure Sensor Open	When the controller detects that the oil pressure sensor is open circuit and the action select "Warn", it will initiate a warning alarm and the corresponding alarm information will be displayed on LCD.

## 5.2. Shutdown alarm

When controller detects shutdown alarm, it will send signal to open breaker and stop the genset. The alarm information will be displayed on LCD.

Shutdown alarm types are as follows:

No.	tems	Description
1	Digital Input	When digital input port is set as shutdown, and the action is active, it will send a shutdown signal.
2	High Temperature	When controller detects that the water/cylinder temperature has exceeded the pre-set value, it will initiate a shutdown alarm and the corresponding alarm information will be displayed on LCD.
3	Low Oil Pressure	When the controller detects that the oil pressure has fallen below the pre-set value, it will initiate a shutdown alarm and the corresponding alarm information will be displayed on LCD.
4	Over Speed	When the controller detects that the generator speed has exceeded the pre-set value, it will initiate a shutdown alarm and the corresponding alarm information will be displayed on LCD.
5	Under Speed	When the controller detects that the generator speed has fallen below the pre-set value, it will initiate a shutdown alarm and the corresponding alarm information will be displayed on LCD.
6	Loss Of Speed Signal	When the controller detects that the engine speed is 0 and the delay is NOT 0, it will initiate a shutdown alarm and the corresponding alarm information will be displayed on LCD.
7	Gen Over Voltage	When the controller detects that the genset voltage has exceeded the pre-set value, it will initiate a shutdown alarm and the corresponding alarm information will be displayed on LCD.
8	Gen Under Voltage	When the controller detects that the genset voltage has fallen below the pre-set value, it will initiate a shutdown alarm and the corresponding alarm information will be displayed on LCD.

9	Gen Over Current	When the controller detects that the genset current has exceeded the pre-set value and delay is not 0, it will initiate a shutdown alarm and the corresponding alarm information will be displayed on LCD.
10	Fail To Start	If the engine does not fire after the pre-set number of attempts, it will initiate a shutdown alarm and the corresponding alarm information will be displayed on LCD.
11	Gen Over Frequency	When the controller detects that the genset frequency has exceeded the pre-set value, it will initiate a shutdown alarm and the corresponding alarm information will be displayed on LCD.
12	Gen Under Frequency	When the controller detects that the genset frequency has fallen below the pre-set value, it will initiate a shutdown alarm and the corresponding alarm information will be displayed on LCD.
13	Genset Failed	When the controller detects that the genset frequency is 0, it will initiate a shutdown alarm and the corresponding alarm information will be displayed on LCD.
14	Low Fuel Level	When the controller detects that the fuel level has fallen below the pre-set value or detects that the low fuel level input is active, it will initiate a shutdown alarm and the corresponding alarm information will be displayed on LCD.
15	Low Coolant Level	When the controller detects the low coolant level input is active, it will initiate a shutdown alarm and the corresponding alarm information will be displayed on LCD.
16	Temp. Sensor Open	When the controller detects that the temperature sensor is open circuit and the action select "Shutdown", it will initiate a shutdown alarm and the corresponding alarm information will be displayed on LCD.
17	Oil Pressure Sensor	When the controller detects that the oil pressure sensor is open circuit and the action select "Shutdown", it will initiate a shutdown alarm and the corresponding alarm information will be displayed on LCD.

## 6. Connections

Compared with LXC3X20, LXC3X10 has no Mains AC Voltage input terminals.

The rear panel of LXC3X10 and LXC3X20 is as below.

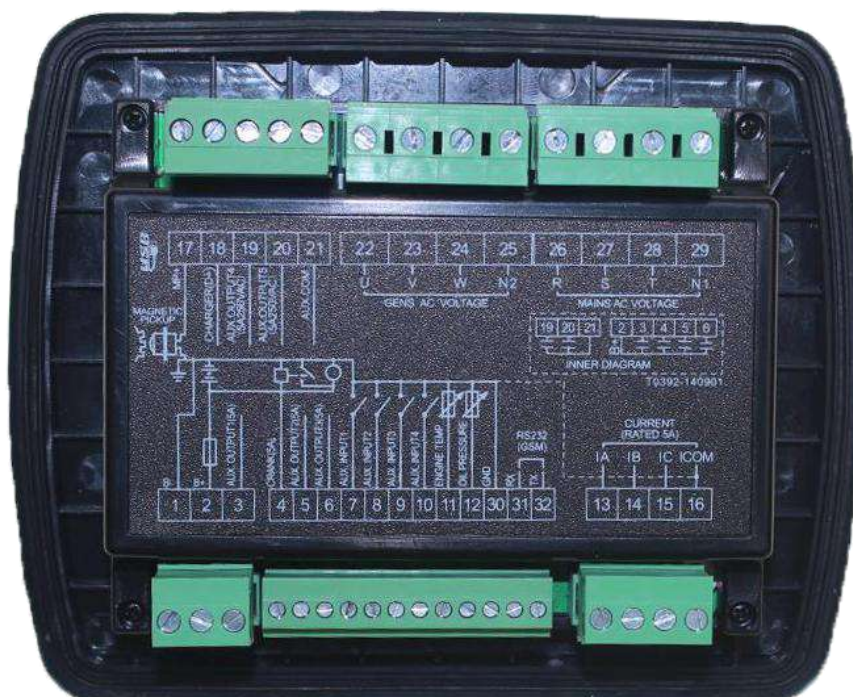

**Description of terminal connections:**

No.	Function	Cable Size	Description	
1	B-	1.5mm <sup>2</sup>	DC power supply. Connected with negative of starter battery.	
2	B+	1.5mm <sup>2</sup>	DC power supply. Connected with positive of starter battery. If wire length is over 30m, better to double wires in parallel. Max. 20A fuse is recommended.	
3	Aux. Output 1	1.0mm <sup>2</sup>	B+ is supplied by 2 point, rated 5A.	
4	Crank	1.0mm <sup>2</sup>	B+ is supplied by 2 point, rated 5A. Connect to starter coil.	
5	Aux. Output 2	1.0mm <sup>2</sup>	B+ is supplied by 2 point, rated 5A.	
6	Aux. Output 3	1.0mm <sup>2</sup>	B+ is supplied by 2 point, rated 5A.	
7	Aux. Input 1	1.0mm <sup>2</sup>	Ground connected is active (B-).	See Table 3
8	Aux. Input 2	1.0mm <sup>2</sup>		
9	Aux. Input 3	1.0mm <sup>2</sup>		
10	Aux. Input 4	1.0mm <sup>2</sup>		
11	Engine Temperature Sensor	1.0mm <sup>2</sup>	Connect to a temperature/cylinder resistance sensor.	See Table 4
12	Oil Press Sensor	1.0mm <sup>2</sup>	Connect to a oil pressure resistance sensor.	
13	CT A Phase Sensing	1.5mm <sup>2</sup>	Outside connected to secondary coil of current transformer(rated 5A)	
14	CT B Phase Sensing	1.5mm <sup>2</sup>		
15	CT C Phase Sensing	1.5mm <sup>2</sup>		
16	CT COM	1.5mm <sup>2</sup>	See INSTALLATION in the manual.	
17	Magnetic Pickup	0.5mm <sup>2</sup>	Connect to speed sensor; Shielded wire is recommended. The other end of speed sensor connects to B-.	
18	Charger D+	1.0mm <sup>2</sup>	Connect to charging starter's D+ terminal. If there is no this terminal, then be hang up.	
19	Aux. Output 4	1.0mm <sup>2</sup>	The combination of terminal 19 and 21 is relay normally open contact; rated 5A; Voltage free.	
20	Aux. Output 5	1.0mm <sup>2</sup>	The combination of terminal 20 and 21 is relay normally open contact; rated 5A; Voltage free.	
21	Aux. Output COM	1.5mm <sup>2</sup>	Common terminal of auxiliary output 4 and 5.	
22	Gen U Phase Sensing	1.0mm <sup>2</sup>	Connected to U-phase of generator (2A fuse is recommended)	

23	Gen V Phase Sensing	1.0mm <sup>2</sup>	Connected to V-phase of generator (2A fuse is recommended)
24	Gen W Phase Sensing	1.0mm <sup>2</sup>	Connected to W-phase of generator (2A fuse is recommended)
25	Gen N2 Input	1.0mm <sup>2</sup>	Connected to N-wire of generator.
26	Mains R Phase Voltage Sensing	1.0mm <sup>2</sup>	Connected to R-phase of mains (2A fuse is recommended) (LXC3X10 without)
27	Mains S Phase Voltage Sensing	1.0mm <sup>2</sup>	Connected to S-phase of mains (2A fuse is recommended) (LXC3X10 without)
28	Mains T Phase Voltage Sensing	1.0mm <sup>2</sup>	Connected to T-phase of mains (2A fuse is recommended) (LXC3X10 without)
29	Mains N1 Sensing	1.0mm <sup>2</sup>	Connected to N-wire of mains (LXC3X10 without)
30	RS232 public grounded pin	0.5mm <sup>2</sup>	Recommended to use shielded cable, single-grounded shield(LXC31X0 series:no this function)
31	RS232 RX	0.5mm <sup>2</sup>	
32	RS232 TX	0.5mm <sup>2</sup>	
USB	USB Interface		Controller directly through the USB line connected to the computer for parametric programming.

## 7. Parameters setting

Start the controller, then press  to enter into the parameters setting menu, see fig below:

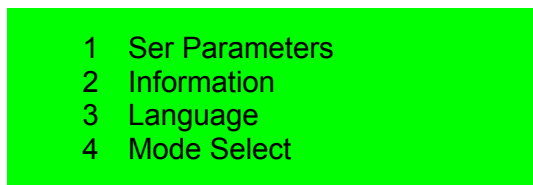

### 7.1. Password Management

❖ **The controller has 2 different password:**

**Technician Password:** Default password: 0000; No. 72 passwords can be changed.

**Operator password :** Default password: 1111; No. 73 passwords can be changed.

❖ **Password Privilege Description:**

**Technician Password:** Has the authority to modify all parameters.

**Operator password:** You can view the parameters of the project, do not have permission to modify parameters.

❖ **If there is need to set more parameters, please contact the factory.**

❖  **NOTES:**

① For LXC3X10, there are no items from 1 to 5 in Table 1; there are no digital outputs about mains .

- ② Please change the controller parameters when generator is in standby mode only (e. g. Crank disconnect conditions selection, digital input, digital output, various delay), otherwise, shutdown and other abnormal conditions may occurs.
- ③ Over voltage set value must be higher than under voltage set value, otherwise the controller will not save the data.
- ④ Over speed set value must be higher than under speed set value, otherwise the controller will not save the data.
- ⑤ Please set the generator frequency value as low as possible when cranking, in order to make the starter be separated quickly as soon as possible.
- ⑥ Digital input 1~4 could not be set as same items; otherwise, there are abnormal functions.
- ⑦ The digital output 1~5 can be set as same items.

❖ **Information**

This interface display controller related information is as follows:

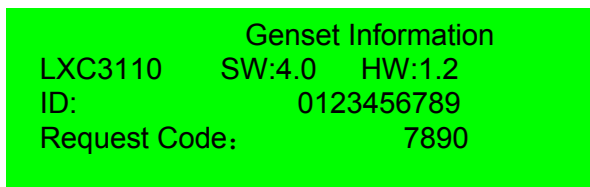

Product Type : LXC3110  
Software Version: SW : 4.0  
Hardware version: HW : 1.2  
Request Code: 7890

If you forget the password you can provide the information to the controller manufacturers, manufacturers will provide a one-time password, you can modify the password to enter configuration menu.

## 7.2. Language

Chinese, English, Spanish and Russian interface can be selected.

## 7.3. Mode Select

The controller can be set as Test Mode, Manual Mode, Auto Mode or Stop Mode.

## 7.4. Definition and range of parameters

The following parameters can be set in the controller.

No.	Items	Range	Default	Description
0	Mains Normal Delay	(0-3600)s	10	The time from mains abnormal to normal or from normal to abnormal; suitable for ATS (automatic transfer switch).
1	Mains Abnormal Delay	(0-3600)s	5	
2	Mains Under Voltage	(30-620)V	184	When mains voltage has fallen below the set value, Mains Under Voltage is active. When set the value as 30V, the controller does not detect under voltage signal. Back lash: 10V (delay of 1 second)
3	Mains Over Voltage	(30-620)V	276	When mains voltage has exceed the set value, Mains Over Voltage is active. When set the value as 620V, the controller does not detect over voltage signal. Back lash: 10V(delay of 1 second)

4	Mains Under frequency	(0-75.0)Hz	45	When mains frequency has fallen below the set value, Mains Under frequency is active. When set the value as 0V, the controller does not detect under frequency signal. Back lash: 2V (delay of 1 second)
5	Mains Over frequency	(0-75.0)Hz	57	When mains frequency has exceed the set value, Mains Over frequency is active. When set the value as 75V, the controller does not detect over frequency signal. Back lash: 2V(delay of 1 second)
6	Transfer Time	(0-99.9)s	1	Interval time from mains switch off to generator switch on; or from generator switch off to mains switch on.
7	Start Delay	(0-3600)s	1	Time from mains abnormal or remote start signal is active to start genset.
8	Stop Delay	(0-3600)s	1	Time from mains normal or remote start signal is deactivated to genset stop.
9	Start number	(1-10)	3	Maximum crank times of crank number. When reach this number, controller will send start failure signal.
10	Preheat Delay	(0-300)s	0	Power-on time of heater plug before starter is powered up.
11	Cranking Time	(3-60)s	8	Power-on time of starter.
12	Crank Rest Time	(3-60)s	10	The waiting time before second power up when engine start fail.
13	Safety On Delay	(1-60)s	10	Alarms for low oil pressure, high temperature, under speed, under frequency / voltage, charge alt failure are inactive.
14	Start Idle Time	(0-3600)s	0	Idle running time of genset when starting.
15	Warming Up Time	(0-3600)s	10	Warming time between genset switch on and high speed running.
16	Cooling Time	(3-3600)s	10	Radiating time before genset stop, after it unloads.
17	Stop Idle	(0-3600)s	0	Idle running time when genset stop.
18	ETS Solenoid Hold	(0-120)s	20	Stop electromagnet's power on time when genset is stopping.
19	Fail to Stop Delay	(0-120)s	0	Time between ending of genset idle delay and stopped when "ETS time" is set as 0; Time between ending of ETS hold delay and stopped when "ETS time" is not 0.
20	Close Time	(0.1-100.0)s	5	Pulse width of mains/generator switch on.
21	Flywheel Teeth	(5-300)	118	Tooth number of the engine, for judging of starter crank disconnect conditions and inspecting of engine speed. See the installation instructions. Tooth number of the engine, for judging of start er crank disconnect conditions and inspecting of engine speed. See the installation instructions. (When genset has no magnetic sensor,please set to 5 to close magnetic sensor)
22	Gen Abnormal	(0-20.0)s	10	The alarm delay of generator over voltage and

	Delay			under voltage.
23	Gen Over Voltage	(30-620)V	264	When generator voltage has exceed the set value and the "Gen abnormal delay" has expired, Gen Over Voltage is active. When set the value as 620V, the controller does not detect over voltage signal.
24	Generator Under Voltage	(30-620)V	196	When generator voltage has fallen below the set value and the "Gen abnormal delay" has expired, Gen Under Voltage is active. When set the value as 30V, the controller does not detect under voltage signal.
25	Under Speed	(0-6000)RPM	1200	When engine speed has fallen below the set value for 10s, Under Speed is active. It will initiate a shutdown alarm signal.
26	Over Speed	(0-6000)RPM	1710	When engine speed has exceed the set value for 2s, Over Speed is active. It will initiate a shutdown alarm signal.
27	Under Frequency	(0-75.0)Hz	45	When generator frequency has fallen below the set value but Not equal to 0 for 10s, Under Frequency is active. It will initiate a shutdown alarm signal.
28	Over Frequency	(0-75.0)Hz	57	When generator frequency has exceed the set value for 2s, Over Frequency is active. It will initiate a shutdown alarm signal.
29	High Temperature	(80-140)°C	98	When the temperature value of the external temperature sensor exceeds the set value, high temperature signal is sent. Detecting only after safety on delay is over. If the set value is 140, high temperature signal will not be sent (this only concerns external temperature sensor, not high temperature signal via configuration. input port).
30	High Temperature Action	(0-1)	0	0: Warning 1: Shutdown.
31	Low Oil Pressure	(0-400) KPa	103	When the external pressure sensor value falls below this set value, low oil pressure signal is sent. Detecting only after safety on delay is over. If the set value is 0, low oil pressure signal will not be sent (this only concerns pressure sensor and does not concern low oil pressure warning signal via configurable input port).
32	Low Oil Pressure Action	(0-1)	0	0: Warning 1: Shutdown.
33	Loss of Speed Signal	(0-20.0)s	5	If the set value is 0, only warning and not to shutdown the generator.
34	Charge Alt Failure (Warning)	(0-30)V	6	During generator is normal running, when alternator D+(WL) voltage has fallen below the set value and remains for 5s, It generates charging failed warning. ( <b>Return value is 1V</b> )
35	Battery Over Voltage (Warning)	(12-40)V	33	When battery voltage has exceeds the set value and remains for 20s, It will initiate a warning alarm signal. Only warning and not to shutdown the generator. ( <b>Return value is 1V</b> )
36	Battery Under Voltage (Warning)	(4-30)V	8	When battery voltage has fallen below the set value and remains for 20s, It will initiate a warning



				alarm signal. Only warning and not to the generator. (Return value is 1V)
37	Current Trans.	(5-6000)/5	500	The ratio of external CT .
38	Full Current Rating	(5-6000)A	500	Generator's rated current, standard of load current.
39	Over Current Percentage	(50-130)%	120	When the load current has exceed the set value, "over current" delay is initiated.
40	Over Current Delay	(0-3600)s	1296	When load current has exceed the set value and the "over current" delay has expired, over current is initiated. When the set value is 0, only warning and not to shutdown the generator.
41	Gens on load Frequency	(0-75.0)Hz	45	When the generator to load conditions (load frequency / load / voltage / load speed), begin to load transfer (Gens load action).
42	Gens on load Volt	(30-620)V	196	
43	Gens on load Speed	(0-6000)RPM	1200	
44	Digital Output 1	(0-74)	1	Factory default: Fuel Relay Output
45	Digital Output 2	(0-74)	13	Factory default: Energized To Stop
46	Digital Output 3	(0-74)	10	Factory default: Idle Control
47	Digital Output 4	(0-74)	14	Factory default: Close Generator
48	Digital Output 5	(0-74)	19	Factory default: Mains Closed
49	Digital Input 1 Type	(0-29)	3	Factory default: High Temperature Input
50	Digital Input 1 Active	(0-1)	0	Factory default: Close to active
51	Digital Input 1 Action	(0-2)		Never/Warning/Shutdown
52	Digital Input 1 Period	(0-3)		Never/From safety on/From Crank/Away.
53	Digital Input 1 Delay	(0-20.0)s		Delay output function.
54	Digital Input 2 Type	(0-29)	4	Factory default: Low Oil Pressure Warning Input.
55	Digital Input 2 Active	(0-1)	0	Factory default: Close to active.
56	Digital Input 2 Action	(0-2)		Never/Warning/Shutdown.
57	Digital Input 2 Period	(0-3)		Never/From safety on/From Crank/Away.
58	Digital Input 2Delay	(0-20.0)s		Delay output function.
59	Digital Input 3 Type	(0-29)	10	Factory default: Remote Start.

60	Digital Input 3 Active	(0-1)	0	Factory default: Close to active.
61	Digital Input 3 Action	(0-2)		Never/Warning/Shutdown.
62	Digital Input 3 Period	(0-3)		Never/From safety on/From Crank/Away.
63	Digital Input 3 Delay	(0-20.0)s		Delay output function.
64	Digital Input 4 Type	(0-29)	0	Factory default: User Configured
65	Digital Input 4 Active	(0-1)	0	Factory default: Close to active
66	Digital Input 4 Action	(0-2)	1	Never/Warning/Shutdown.
67	Digital Input 4 Period	(0-3)	2	Never/From safety on/From Crank/Away.
68	Digital Input 3 Delay	(0-20.0)s	2	Delay output function
69	Power On Mode	(0-2)	0	0: Stop Mode 1: Test Mode 2: Manual Mode 3: Auto mode.
70	Module Address	(1-247)	1	Communication address of controller.
72	technician password	(0-9999)	1	The technician password authorization, Has the authority to modify all parameters.
73	operator password	(0-9999)	2	The operator password can only observe the configuration parameters, and cannot be modified.
74	Crank Disconnect	(0-8)	6	There are 3 conditions of disconnecting starter with engine. Each condition can be used alone and simultaneously to separating the start motor and genset as soon as possible.
75	Disconnect Engine Speed	(0-3000)RPM	360	When engine speed higher than the set value, starter will be disconnected.
76	Disconnect Generator Freq	(10.0-30.0)Hz	14	When generator frequency higher than the set value, starter will be disconnected.
77	Disconnect Oil Pressure	(0-400)KPa	200	When generator oil pressure higher than the set value, starter will be disconnected.
78	D+ Disconnect	(3.0-32.0)V	8	When generator D+ higher than the set value, starter will be disconnected.
79	Voltage Input	(0-3)	0	0: 3P4W; 1: 2P3W 2: 1P2W; 3: 3P3W Note 3
80	Poles	(2-16)	4	
81	Temp. Sensor Curve	(0-9)	1	VDO120°C
82	Oil Pressure Sensor Curve	(0-9)	1	VDO0-10BAR
83	Temperature Sensor Open	(0-2)	1	0: Never (temperature sensor will show “+++”); 1: Warn; 2: Shutdown
84	Oil Pressure Sensor Open	(0-2)	1	
85	Configuration Sensor Curve	(0-1)	0	Temperature and oil pressure sensor curve can be defined.
86	Parameters selection			Enter the parameter number, press confirm to quickly jump to the parameter setting items.

## 7.5. Programmable input 1-4 table (Active when connect GND (B-))

No	Type	Description
0	Users Configured	<p>Including following functions:</p> <p>-----</p> <p>Warning: warn only, not shutdown.            Shutdown: alarm and shutdown immediately.            Trip and stop: alarm, generator unloads and shutdown after hi-speed cooling.            Trip: alarm, generator unloads but not shutdown.            Indication: indicate only, not warning or shutdown.</p> <p>-----</p> <p>From safety on: detecting after safety on run delay.            From crank: detecting as soon as start.            Always: input is active all the time.            Never: input inactive</p>
1	Alarm Mute	Can prohibit "Audible Alarm" output when input is active.
2	Reset Alarm	Can reset shutdown alarm and trip alarm when input is active.
3	Aux High Temp	Connected sensor digital input.
4	Aux Low OP	Connected sensor digital input.
5	Inhibit Alarm Stop	Prohibit any alarm and shutdown action.
6	Remote Start On Load	In Auto mode, when input active, genset can be started and with load after genset is OK; when input inactive, genset will stop automatically.
7	Remote Start Not On Load	In Auto mode, when input is active, genset can be started and without load after genset is OK; when input is inactive, genset will stop automatically.
8	Aux Manual Start	In Auto mode, when input active, genset will start automatically; when input inactive, genset will stop automatically.
9	Simulation Mains OK	In Auto mode, mains are normal when input is active.
10	Simulation Mains Fail	In Auto mode, mains are abnormal when input is active.
11	Panel Lock	Generator related operations are banned, switch query interface can be used.
12	Inhibit Auto Stop	In Auto mode, during generator normal running, when input is active, inhibit generator shutdown automatically.
13	Inhibit Auto Start	In Auto mode, inhibit generator start automatically when input is active.
14	Inhibit Gens Load	Prohibit genset switch on when input is active.
15	Inhibit Mains Load	Prohibit mains switch on when input is active.
16	Auto Mode Lock	When the input is active, the controller will operate in automatic mode, you can not select the test mode and manual mode.
17	Auto Mode Invalid	When input is active, controller won't work under Auto mode. AUTO key and simulate auto key input does not work.
18	Idle Control Mode	Under voltage/frequency/speed protection is inactive.
19	Instrument Mode	All outputs are prohibited in this mode.
20	Generator Closed	Connect generator loading switch's Aux. Point.
21	Mains Closed	Connect mains loading switch's Aux. Point.
22	Aux Raise Speed	This configuration is for the use of motor adjust the speed of the unit, and raise speeding output with control motor. When this switch is closed, raise speed output will turn off.
23	Aux Drop Speed	This configuration is for the use of motor adjust the speed of the unit, and drop speeding output with control motor. When this switch is closed, raise speed output will turn off.

24	Simulate Stop key	An external button can be connected and pressed as simulate panel.
25	Simulate Manual key	
26	Simulate Manual Test key	
27	Simulate Auto key	
28	Simulate Start key	
29	Lamp Test	All LED indicators are illuminating when input is active.

## 7.6. Programmable output 1-5

No.	Type	Description
0	Not Used	
1	Fuel Relay	Action before the starter motor, open the fuel system in advance. Usually controls the governor's power and fuel solenoid valve.
2	Crank Relay	When starting the motor action, often connected to the starter relay.
3	Air Flap	Action in over speed alarm stop and emergence stop. It also can close the air inflow the engine.
4	Audible Alarm	Action in warning,shutdown,trips.Can be connected outside alarm.When programmable input port is active of“alarm mute”, can prohibit its output.
5	Louver Control	Action in genset starting and disconnect when genset stopped completely.
6	Fuel Pump Control	It is controlled by fuel pump of level sensor's limited threshold.
7	Heater Control	It is controlled by heating of temperature sensor's setting bound.
8	Excite Generator	Output in start period. If there is no gens frequency during hi-speed running, output 2 seconds again.
9	Pre-Lubricate	Actions in period of pre-heating to safety run.
10	Idle Control	Used for engine which has idles.Pull in before starting and pull out after into hi-speed warming; Pull in during stopping idle mode and pull out after shutdown completed.
11	Raise Speed	Action in hi-speed warming run.
12	Drop Speed	Action in period of stop idle mode to time of wait for stopping completely.
13	ETS Control	Used for engines with ETS electromagnet. Pull in when stop idle is over and pull out when set“ETS delay”is over.
14	Close Generator	Generator load conditions are ripe for action, control power closing switch with load. It is a continuous output.
15	Close Generator Pulse	The same role,but is not a continuous output, but only the output pulses of a preset time.This time set in the timer configuration.
16	Open Generator	Generator stop action, control power generation closing switch uninstal.
17	Open Generator Pulse	The same role,but is not a continuous output, but only the output pulses of a preset time.This time set in the timer configuration.
18	Open Breaker	Gens whether or mains is opened, will be output. It is a common sub-gate output.
19	Close Mains	Control switch of mains is load.
20	Close Mains Pulse	
21	Open Mains	
22	Open Mains Pulse	
23	Generator OK	Action when gens are normal.
24	Generator Available	Action in period of gens normal to hi-speed cooling.
25	Crank Success	Pull in when detects a successful start signal.
26	Mains OK	Action when mains are normal.

27	In Stop Mode	
28	In Manual Mode	
29	In Manual Test Mode	
30	In Auto Mode	
31	Generator On Load	
32	Mains On Load	
33	Common Alarm	Action in gens common warning,common shutdown, common trips alarm.
34	Common trip shutdown	The generators any kind of trip and downtime will produce such an alarm action.
35	Common Shutdown	Generator any downtime will have such alarm action.
36	Common Trip Alarm	Generators will produce any kind of trip the alarm action.
37	Common Warn Alarm	Generators of any kind of public warning alarm is generated action.
38	Battery Hight Voltage	An action in battery's over voltage warning alarm.
39	Battery Low Voltage	Action in battery's low voltage warning alarm.
40	Charging failure	Action in charge alt fail warning alarm.
41	Emergency Stop	Action in emergency stop alarm.
42	Failed To Start	Action in failed start alarm.
43	Failed To Stop	Action in failed stop alarm.
44	Under Speed Warn	Action in under speed warning.
45	Under Speed Shutdown	Action in under speed shutdown.
46	Over Speed Warn	Action in over speed warning.
47	Over Speed Shutdown	Action in over speed shutdown alarm.
48	Gens Over Freq Warn	Action in gens over frequency warning.
49	Gens Over Freq Shutdown	Action in gens over frequency shutdown alarm.
50	Gens Over Volt Warn	Action in gens over voltage shutdown.
51	Gens Over Volt Shutdown	Action in gens low frequency warning.
52	Gens Under Freq Warn	Action in gens low frequency shutdown.
53	Gens Under Voltage Warn	Action in gens low voltage warning.
54	Gens Under Volt Shutdown	Action in gens low voltage shutdown.
55	Gens Under Volt Shutdown	Action in gens low voltage shutdown.
56	Gens Loss Of Phase	Action in gens loss phase.
57	Gens Reverse Phase	Action in gens reverse phase.
58	Over Current	Action in over current.
59	Mains Inactive	Action in mains Inactive .
60	Mains Over Freq	Action in mains over frequency.
61	Mains Over Voltage	Action in mains over Voltage.
62	Mains Under Freq	Action in mains under frequency.
63	Mains Under Volt	Action in mains under Voltage.
64	Mains Reverse Phase	When phase sequence of 3 phase input mistake.
65	Mains Loss Of Phase	Action in mains loss Of Phase.
66	High Temp Warn	Action in low temperature warning alarm.
67	High Temp Shutdown	Action in high temperature Shutdown alarm.
68	Low Oil Pressure Warn	Action in low oil pressure warning alarm.
69	Low Oil Pressure Shutdown	Action in low oil pressure shutdown.
70	OP Sensor Open	Action when oil pressure sensor are open circuit.
71-74	Aux Input 1-4Active	

## 7.7. Sensor select

Temperature Sensor	Oil Pressure Sensor	Description
0 Not used	0 Not used	Defined resistive range is(0-6000) $\Omega$
1 VDO 120 $^{\circ}$ C	1 VDO 0-10BAR	
2 CURTIS	2 CURTIS	
3 VOLVO-EC	3 VOLVO-EC	
4 DATCON	4 DATCON 10BAR	
5 SGX	5 SGX	
6 SGD	6 SGD	
7 SGH	7 SGH	
8 PT100	8 Custom Res Curve	
9 Custom Res Curve	9 Reserved	

### NOTE:

- ❖ Is there a difference if standard curve of sensor with the use of sensors,can be change by itself in the custom curve,when the sensor selection is "no", the curve of sensor doesn't work.
- ❖ If the corresponding sensors, only alarm switch, is the sensor must be set to "no", otherwise likely stop alarm or warning.

## 7.8. Conditions of crank disconnect

NO.	Description
0	Generator Frequency
1	Magnetic pickup
2	Magnetic pickup +Generator Frequency
3	Oil pressure
4	Oil pressure+Generator Frequency
5	Oil pressure+Magnetic pickup
6	Oil pressure+Magnetic pickup +Generator Frequency
7	Charge D+
8	Oil pressure+Charge D+





- ❖ There are 4 conditions to make starter disconnected with engine,that is,speed sensor, generator frequency, Charge D+ and engine oil pressure. They all can be used separately. We recommend that engine oil pressure should be using with speed sensor and generator frequency together, in order to make the starter motor is separated with engine immediately and can check crank disconnect exactly.
- ❖ Speed sensor is the magnetic equipment which be installed in starter for detecting flywheel teeth.
- ❖ When set as speed sensor, must ensure that the number of flywheel teeth is as same as setting, otherwise, "over speed stop" or "under speed stop" may be caused.
- ❖ If genset without speed sensor, please don't select corresponding items, otherwise, "start fail" or "loss speed signal" maybe caused.
- ❖ If genset without oil pressure sensor, please don't select corresponding items.
- ❖ If not select generator in crank disconnect setting, controller will not collect and display the relative power quantity (can be used in water pump set); if not select speed sensor in crank disconnect setting, the rotating speed displayed in controller is calculated by generator frequency and number of poles.

- ❖ If the generator without magnetolectric sensor and Oil pressure sensor, the "Charger D+" is optional as a starter motor separation conditions. It is recommended to select "Oil Pressure+ Charger D+" for safety.

## 7.9. Sensor select

- ❖ When reselect sensors, the sensor curve will be transferred into the standard value.
- ❖ When there is difference between standard sensor curves and the using sensor, user can adjust it in "curve type"  via PC. After the adjustment is completed, the data will be saved to the "custom resistance curve" option. Using a custom sensor when choosing the sensor options "Custom resistance curve."
- ❖ In the control panel, the same can customize the sensor curve, such as setting the project is "85. Custom sensor curve."

The specific operation as follows:

- ① Switch to **【85 custom sensor curve】** interface.
  - ② Press  key to enter the sensor type selected, press   to switch type.
  - ③ Select Custom sensor curve type, pass  button to enter the data setting interface.
  - ④ After setting, press  button to return to the previous menu.
- ❖ If select sensor type as "None", sensor curve is not working and LCD display "---" for the sensor information.
  - ❖ If there is no oil pressure sensor, but there is low oil pressure alarm switch, user must set the oil pressure sensor as "None", otherwise, maybe low oil pressure shutdown occurs.

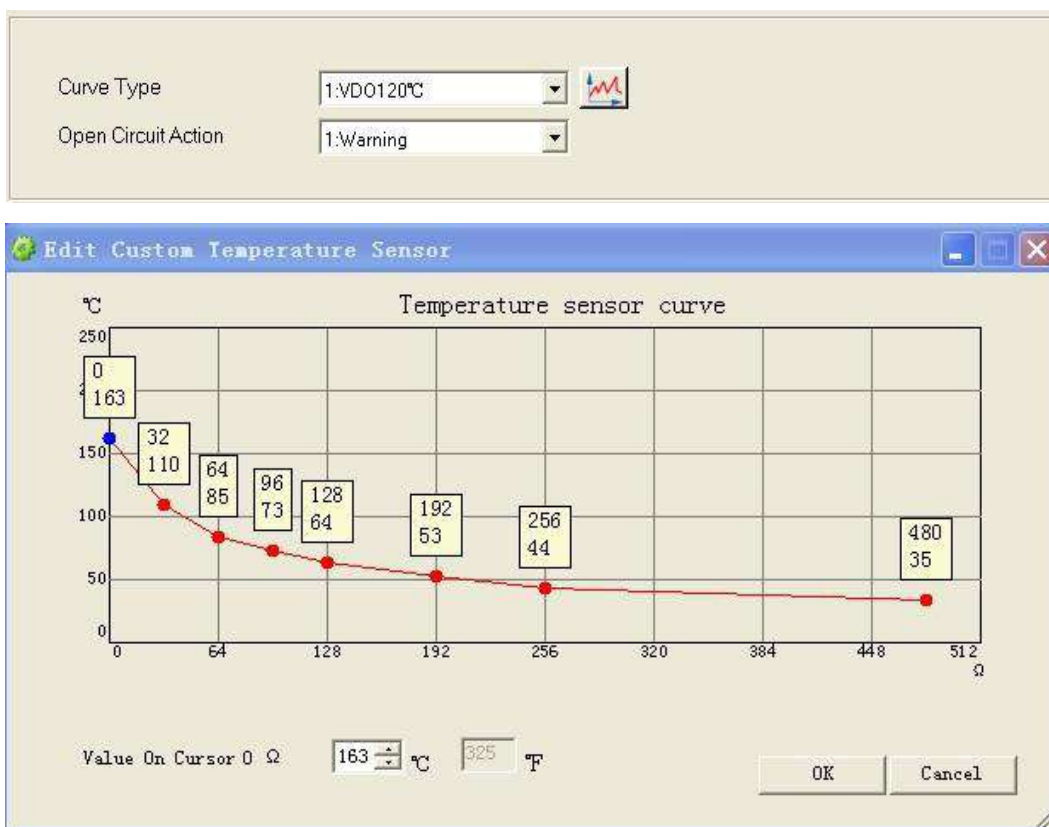

## 7.10. Sensor unit conversion table

	N/m <sup>2</sup> pa	kgf/cm <sup>2</sup>	bar	p/in <sup>2</sup> .psi
1Pa	1	1.02x10 <sup>-5</sup>	1x10 <sup>-5</sup>	1.45x10 <sup>-4</sup>
1kgf/cm <sup>2</sup>	9.8x10 <sup>4</sup>	1	0.98	14.2
1bar	1x10 <sup>5</sup>	1.02	1	14.5
1psi	6.89x10 <sup>3</sup>	7.03x10 <sup>-2</sup>	6.89x10 <sup>-2</sup>	1

## 8. Commissioning

Please make the under procedures checking before commissioning.

- ❖ Ensure all the connections are correct and wires diameter is suitable.
- ❖ Ensure that the controller DC power has fuse, controller's positive and negative connected to start battery are correct.
- ❖ Take proper action to prevent engine to crank success (e. g. Remove the connection wire of fuel valve). If checking is OK, make the start battery power on; choose manual mode and controller will executive routine.
- ❖ Set controller under manual mode, press "start" button, genset will start. After the cranking times as setting, controller will send signal of Start Failure; then press "stop" to reset controller. Recover the action to prevent engine to crank success (e. g. Connect wire of fuel valve), press start button again, genset will start. If everything goes well, genset will normal running after idle running (if idle run be set). During this time, please watch for engine's running situations and AC generator's voltage and frequency. If abnormal, stop genset and check all wires connection according to this manual.
- ❖ Select the AUTO mode from controller's panel, connect mains signal. After the mains normal delay, controller will transfer ATS (if fitted) into mains load. After cooling time, controller will stop genset and make it into "at rest" mode until there is mains abnormal situation.
- ❖ When mains is abnormal again, genset will be started automatically and enter into normal running, then controller send signal to making generator switch on, and control the ATS transfer into generator load. If not like this, please check ATS' wires connection according to this manual.
- ❖ If there is any other question, please contact Tuancheng's service.

 **CAUTION!** Expand relay with high capacity in start and fuel output is recommend.

 **CAUTION!** Expand relay must be used in mains/gen closed outputs.

 **CAUTION!** Let its normally closed contact series connect between fuel relay output port and electromagnetic valve when you connect emergency stop button on the controller. Emergency stop alarm can be displayed if you configure one input port as "Auxiliary Shutdown" (one end connect to normally open contact, the other end connect to ground).



## 9. Typical application

### LXC3X10 Typical wiring diagram

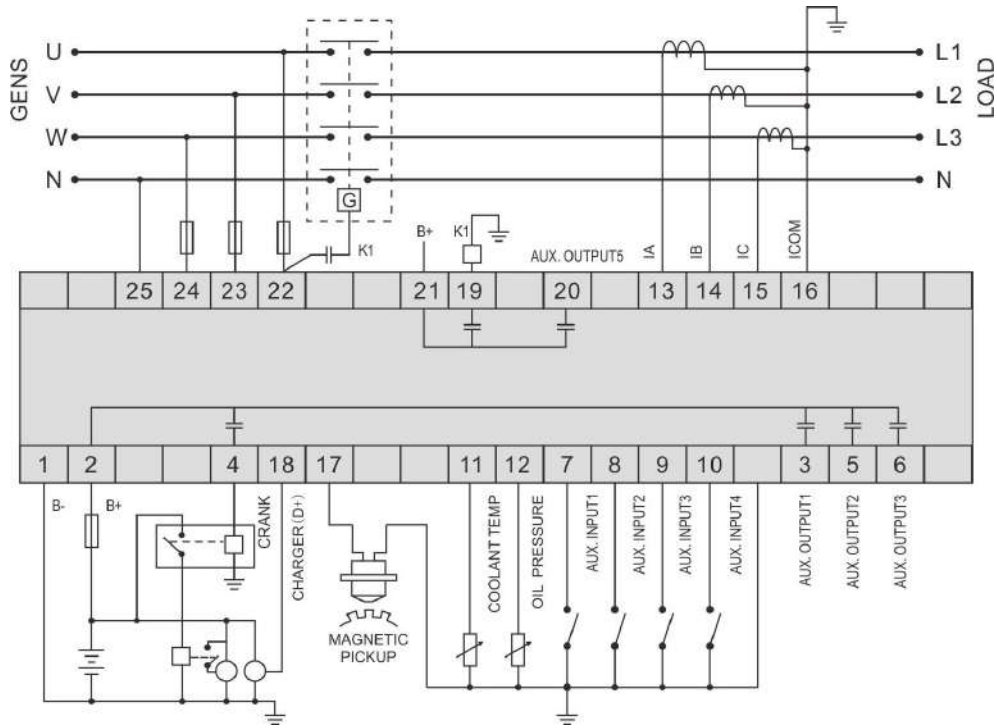

### LXC3X20 Typical wiring diagram

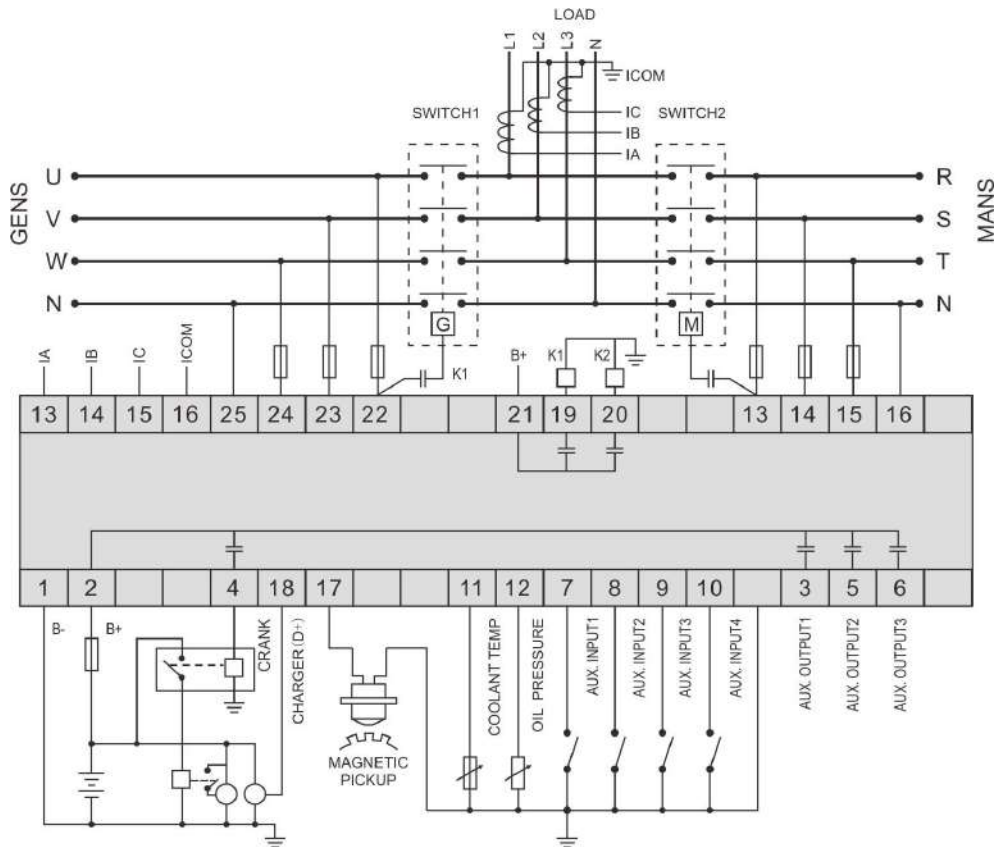

### Single Phase 2 Wire( LXC3X20 )

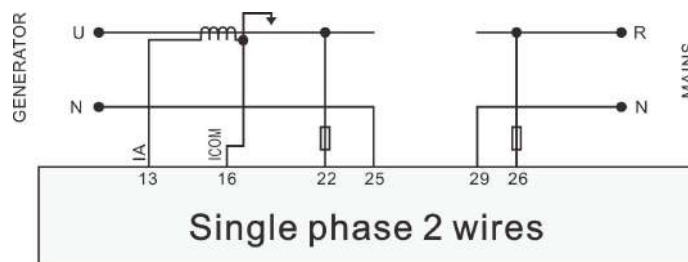

### 2 Phase 3 Wire( LXC3X20 )

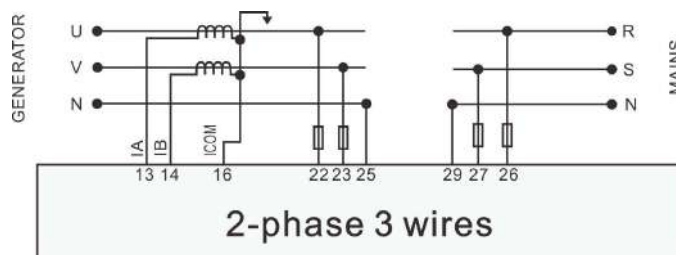

**CAUTION!** Expand relay with high capacity in start and fuel output is recommend.

**CAUTION!** Expand relay must be used in mains/gen closed outputs.

**CAUTION!** Let its normally closed contact series connect between fuel relay output port and electromagnetic valve when you connect emergency stop button on the controller. Emergency stop alarm can be displayed if you configure one input port as "Auxiliary Shutdown" (one end connect to normally open contact, the other end connect to ground).

## 10. Installation

### 10.1. Fixing clips

Controller is panel built-in design; it is fixed by clips when installed.

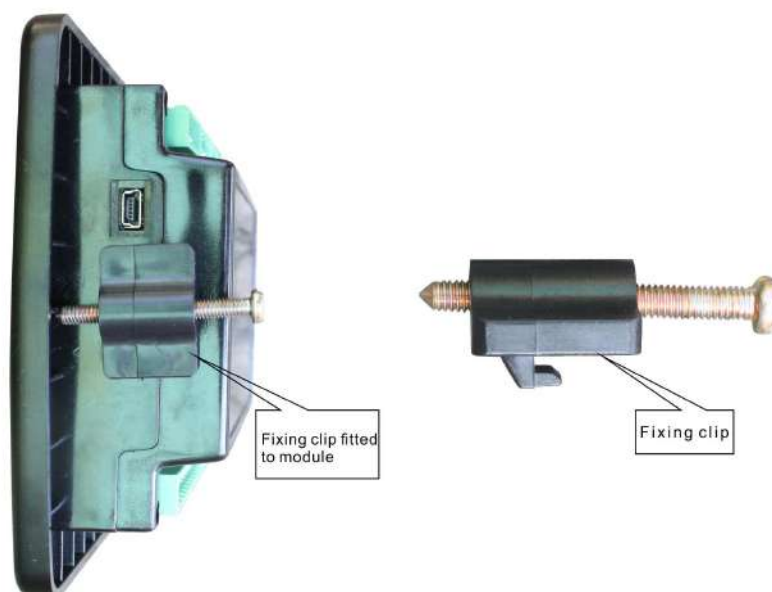

## 10.2. Overall dimension and panel cutout

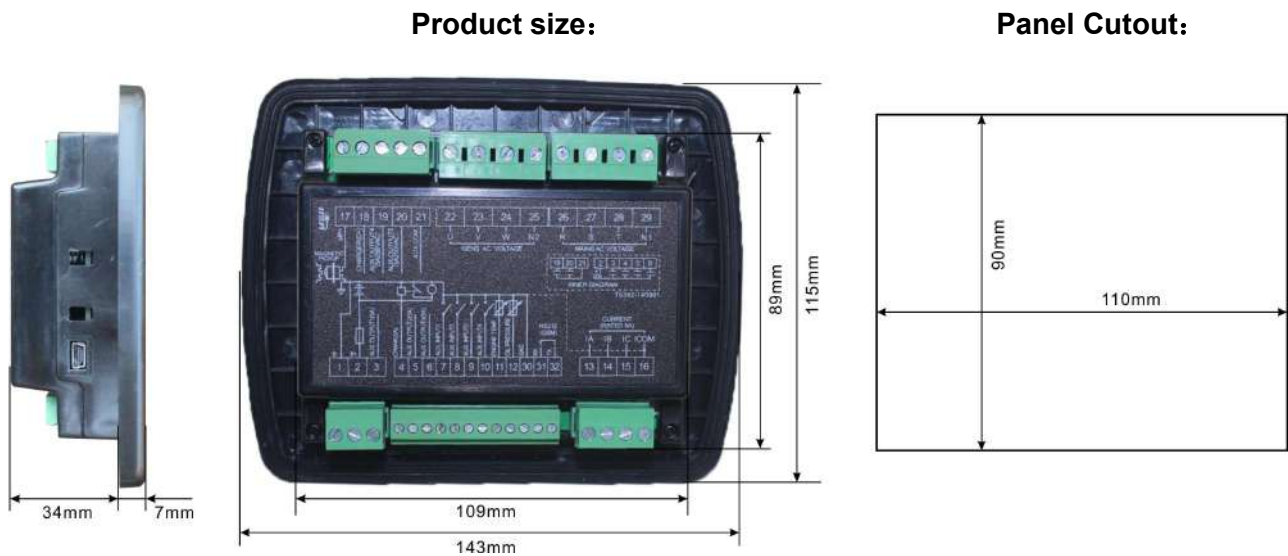

### ❖ Battery Voltage Input

LXC31X0/LXC39X0 series controller can suit for widely range of battery voltage DC(8~35)V. Negative of battery must be connected with the engine shell. The diameter of wire which from power supply to battery must be over 1.5mm. If floating charge configured, please firstly connect output wires of charger to battery's positive and negative directly, then, connect wires from battery's positive and negative to controller's positive and negative input ports in order to prevent charge disturbing the controller's normal working.

### ❖ Speed Sensor Input

Speed sensor is the magnetic equipment which be installed in starter and for detecting flywheel teeth. Its connection wires to controller should apply for 2 cores shielding line. The shielding layer should connect to No. 1 terminal in controller while another side is hanging in air. The else two signal wires are connected to No.1 and No.17 terminals in controller. The output voltage of speed sensor should be within AC(1~24)V (effective value) during the full speed. AC12V is recommended (in rated speed). When install the speed sensor, let the sensor is spun to contacting flywheel first, then, port out 1/3 lap, and lock the nuts of sensor at last.

### ❖ Output And Expansion Relay

All outputs of controller are relay contact output type. If need to expand the relays, please add freewheel diode to both ends of expand relay's coils (when coils of relay has DC current) or, add resistance-capacitance return circuit (when coils of relay has AC current), in order to prevent disturbance to controller or others equipment.

### ❖ AC Input

LXC31X0/LXC39X0 series controller must be connected to outside current transformer. And the current transformer's secondary side current must be 5A. At the same time, the phases of current transformer and input voltage must correct. Otherwise, the collected current and active power maybe not correct.



**CAUTION!** ICOM port must be connected to negative pole of battery.



**WARNING!** When there is load current, transformer's secondary side prohibit open circuit.

❖ **Withdraw Voltage Test**

When controller had been installed in control panel, if need the high voltage test, please disconnect controller's all terminal connections, in order to prevent high voltage into controller and damage it.

## 11. Fault finding

Following in my controller process more common failure and troubleshooting, if there is a failure of the other can not be solved, please contact my company.

Symptom	Possible Remedy
Controller no response with power.	Check starting batteries; Check controller connection wirings; Check DC fuse.
Genset shutdown	Check the water/cylinder temperature is too high or not; Check the genset AC voltage; Check DC fuse.
Controller emergency stop	Check emergence stop button is correct or not; Check whether the starting battery positive be connected with the emergency stop input; Check whether the circuit is open.
Low oil pressure alarm after crank disconnect	Check the oil pressure sensor and its connections.
High water temp. alarm after crank disconnect	Check the temperature sensor and its connections.
Shutdown Alarm During Running	Check related switch and its connections according to the information on LCD; Check auxiliary inputs.
Crank not disconnect	Check fuel circuit and its connections; Check starting batteries; Check speed sensor and its connections; Refer to engine manual.
Starter no response	Check starter connections; Check starting batteries.
Genset running while ATS not transfer	Check ATS; Check the connections between ATS and controllers.

## 12. Product packaging



**This product should be following sets:**

- (1) 1 piece of controller;
- (2) 2 pieces of fixed cards;
- (3) 1 piece of Shockproof rubber ring;
- (4) 1 piece of product certificate;
- (5) 1 piece of product mutual.

**Dongguan Tuancheng Automation Equipment Co.,LTD.**

**Tel:**+86-769-23836636

**Fax:**+86-769-23166296

**http://www.lixise.com**

**http://www.lixise.net**

**E-mail:**sales@lixise.com

**Add:** Wentang Road, Chashang industrial zone #18, Dongcheng, Dongguan, Guangdong, China