



SmartGen
ideas for power

FPC915

DIESEL ENGINE FIRE PUMP CONTROLLER

USER MANUAL

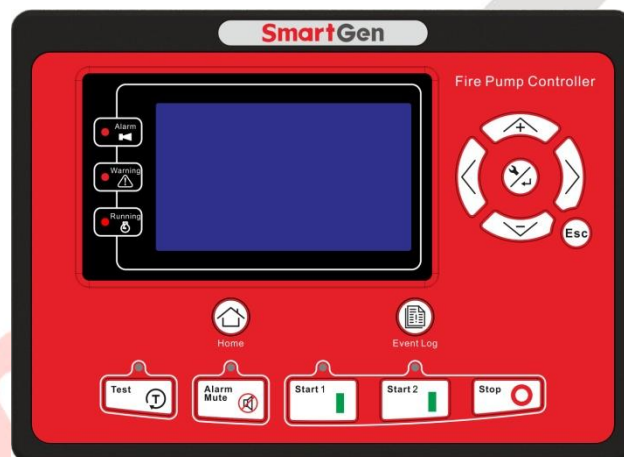

ZHENGZHOU SMARTGEN TECHNOLOGY CO.,LTD.



Chinese trademark

SmartGen English trademark

SmartGen — make your generator *smart*

SmartGen Technology Co., Ltd

No. 28 Jinsuo Road

Zhengzhou City

P. R. China

Tel: 0086-371-67988888

0086-371-67981888

0086-371-67991553

0086-371-67992951

0086-371-67981000 (overseas)

Fax: 0086-371-67992952

Web: www.smartgen.com.cn

www.smartgen.cn

Email: sales@smartgen.cn

All rights reserved. No part of this publication may be reproduced in any material form (including photocopying or storing in any medium by electronic means or other) without the written permission of the copyright holder.

SmartGen Technology reserves the right to change the contents of this document without prior notice.

Software Version

Date	Version	Content
2015-12-10	1.0	Original release.
2017-08-08	1.1	Change the colour of mask to red colour.

CONTENT

1	OVERVIEW	5
2	PERFORMANCE AND CHARACTERISTICS	6
3	SPECIFICATION.....	7
4	OPERATION	8
4.1	INDICATOR LIGHT	8
4.2	PUSHBUTTONS	9
4.3	LCD DISPLAY	10
4.3.1	MAIN DISPLAY	10
4.3.2	USER MENU AND PARAMETERS SETTING MENU	11
4.4	AUTO START/STOP OPERATION.....	14
4.4.1	AUTOMATIC START/STOP CONDITIONS.....	14
4.4.2	AUTOMATIC START SEQUENCE	14
4.4.3	AUTOMATIC STOP SEQUENCE.....	14
4.5	MANUAL START/STOP OPERATION.....	15
5	PROTECTION	16
5.1	WARNINGS.....	16
5.2	SHUTDOWN ALARM.....	18
5.3	INDICATION.....	19
6	CONNECTIONS	20
7	DEFINITION AND RANGE OF PARAMETERS	23
7.1	PARAMETER CONTENTS AND RANGE (FORM 1)	23
7.2	PROGRAMMABLE OUTPUT	29
7.2.1	PROGRAMMABLE OUTPUT 1-5 (FORM 2).....	29
7.2.2	CUSTOM PERIOD OUTPUT	32
7.2.3	CUSTOM COMBINED OUTPUT.....	33
7.3	DEFINED CONTENTS OF CONFIGURABLE INPUT PORTS (ALL ACTIVE WHEN CONNECT TO GRAND (B-))(FORM3).....	34
7.4	SELECTION OF SENSORS (FORM4).....	35
7.5	CONDITIONS OF CRANK DINSCONNECT SELECTION (FORM5)	36
7.6	MAINTENANCE (FORM 6).....	37
8	SENSOR SELECT.....	38
9	TYPICAL APPLICATION.....	39
10	INSTALLATION.....	40
11	CONNECTIONS OF CONTROLLER WITH J1939 ENGINE	41
11.1	CUMMINS ISB/ISBE	41
11.2	CUMMINS QSL9.....	41
11.3	CUMMINS QSM11	41
11.4	CUMMINS QSX15-CM570	42
11.5	CUMMINS GCS-MOVBUS	42
11.6	CUMMINS QSM11	42



11.7	CUMMINS QSZ13.....	43
11.8	DETROIT DIESEL DDEC III / IV	43
11.9	DEUTZ EMR2	43
11.10	JOHN DEERE	44
11.11	MTU MDEC.....	44
11.12	MTU ADEC(SMART MODULE).....	44
11.13	MTU ADEC(SAM MODULE).....	45
11.14	PERKINS.....	45
11.15	SCANIA.....	45
11.16	VOLVO EDC3.....	45
11.17	VOLVO EDC4.....	46
11.18	VOLVO-EMS2	46
11.19	YUCHAI.....	47
11.20	WEICHAJ.....	47
12	USB.....	47
13	FAULT FINDING	48

1 OVERVIEW

FPC915 Diesel Driven Fire Pump Controller is designed for fire pump systems which controlled by engine. It allows automatic start/stop, data measurement, alarm protection functions. CANBUS (SAE J1939) interface enables the controller to communicate with various engine which fitted with J1939 interface.

FPC915 Diesel Driven Fire Pump Controller fit with LCD display, optional languages interface (including English, Chinese or other languages); simultaneously the exact parameters of pump unit and engine are indicated by the LCD display on the front panel and the controller is reliable and easy to use. adopt powerful 32-bit ARM microprocessor technology with precision parameters measuring, fixed value adjustment, time setting and set value adjusting and etc. The majority of parameters can be configured from front panel and all the parameters can be set using PC (via USB port). It can be widely used in a number of pump control systems with compact structure, simple connections and high reliability.

2 PERFORMANCE AND CHARACTERISTICS

- 480x272 pixel, 4.3 inches coloured TFT-LCD with backlight, multilingual interface (including English, Chinese or other languages) which can be chosen at the site, making commissioning convenient for factory personnel.
- Improved LCD wear-resistance and scratch resistance due to hard screen acrylic.
- Silicon panel and pushbuttons for better operation in high/low temperature environment.
- RS485 communication port enabling remote control, remote measuring, remote communication via ModBus protocol.
- Equipped with CANBUS port and can communicate with J1939 genset. Not only can you monitoring frequently-used data (such as water temperature, oil pressure, engine speed, fuel consumption and so on) of ECU machine, but also control start, stop, simultaneously expand module via CANBUS port.
- Discharge pressure curve and flow curve are user-defined.
- Multiple analog sensors; sensors can switch between resistor type and current type using jumper.
- More kinds of curves of temperature, oil pressure, fuel level can be used directly and users can define the sensor curves by themselves.
- Precision measure and display parameters about Engine and pump unit; e.g. engine high water temperature, low oil pressure, over speed, high water pressure, low water pressure, over flow and other kinds of fault indication and protection function..
- All output ports are relay-out;
- Parameter setting: parameters can be modified and stored in internal FLASH memory and cannot be lost even in case of power outage; most of them can be adjusted using front panel of the controller and all of them can be modified using PC via USB port.
- Multiple crank disconnect conditions (speed sensor, oil pressure) are optional;
- Widely power supply range DC(8~35)V, suitable to different starting battery voltage environment;
- Event log, real-time clock, scheduled start & stop pump unit (can be set as start pump unit once a day/week/month whether with load or not);
- Accumulative total run time A and B. Users can reset it as 0 and re-accumulative the value which make convenience to users to count the total value as their wish.
- Can control engine heater, cooler and fuel pump.
- With maintenance function. Actions can be set when maintenance time out;
- All parameters used digital adjustment, instead of conventional analog modulation with normal potentiometer, more reliability and stability;
- Waterproof security level IP55 due to rubber seal installed between the controller enclosure and panel fascia;
- Metal fixing clips enable perfect performance in high temperature environment;
- Modular design, anti-flaming ABS plastic enclosure, pluggable connection terminals and embedded installation way; compact structure with easy mounting.

3 SPECIFICATION

Items	Contents
Working Voltage	DC8.0V to 35.0V, Continuous Power Supply.
Overall Consumption	<4W(Standby mode: ≤2W)
Speed Sensor Voltage	1.0 to 24V(effective value)
Speed Sensor Frequency	10000Hz (max)
Start Relay Output	16Amp DC28V power supply
Fuel Relay Output	16Amp DC28V power supply
Active Relay Output	7Amp DC28V power supply
Voltage Free Relay Output	7Amp AC250V voltage free output
Analog Sensor	5 fixed sensor, 2 configurable sensor
Overall Dimensions	237 mm x 172 mm x 45 mm
Panel Cutout	214mm x 160mm
Working Condition	Temperature: (-25~+70)°C Humidity: (20~93)%RH
Storage Condition	Temperature: (-25~+70)°C
Protection Level	IP55 Gasket
Weight	0.95kg

4 OPERATION

4.1 INDICATOR LIGHT

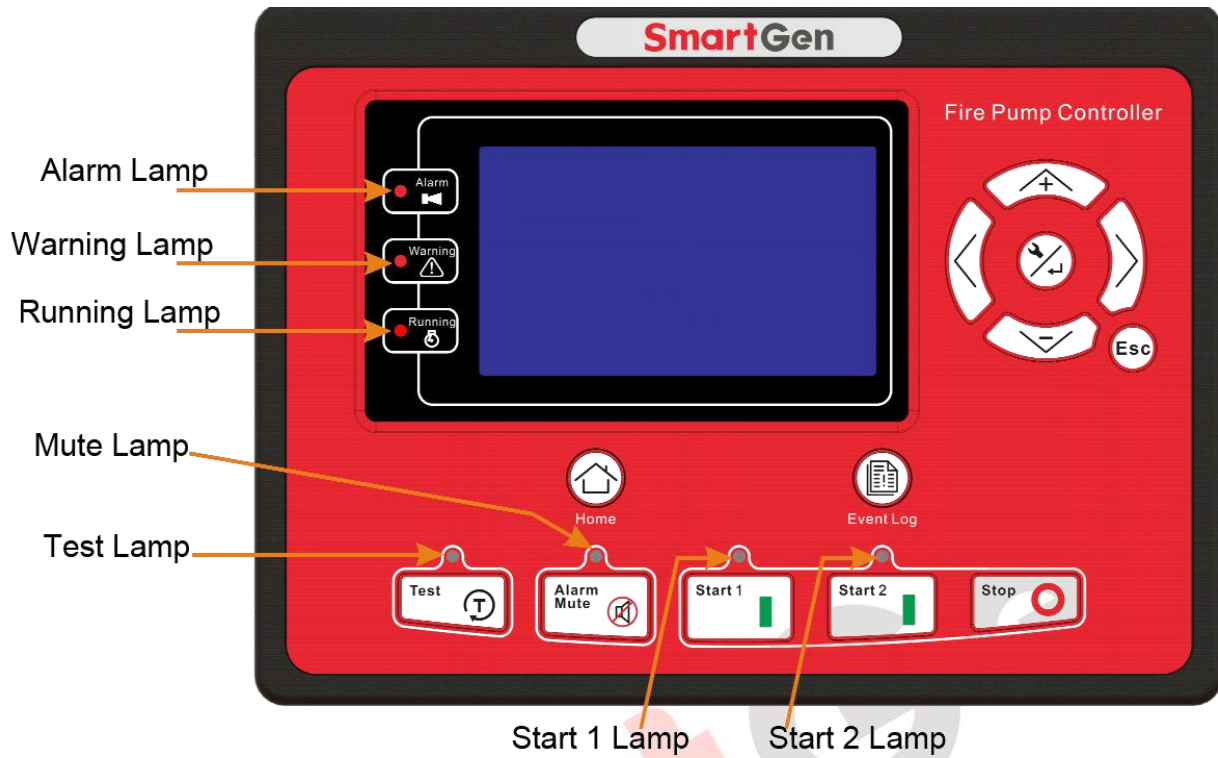













Note: Selected indicators description:

Warning indicator and Alarm indicator:

Alarm Type	Warning Indicator	Alarm Indicator
Warning	Slow flashing	Slow flashing
Shutdown Alarm	Off	Fast flashing

Running indicator: illuminated from crank successful to ETS while off during other periods.





4.2 PUSHBUTTONS

Icon	Name	Description
	Stop	Stop running pump unit in Auto/Manual mode; Reset alarm in stop mode; Lamp test (press at least 3 seconds); During stopping process, press this button again to stop pump unit immediately.
	Start 1	Press this button to start gensets via start battery in Manual mode; after start, starting motor divorced while loose this button.
	Start 2	Press this button to start gensets via control battery in Manual mode; after start, starting motor divorced while loose this button.
	Mute	Alarming sound off.
	Test	Control magnetic valve to open in Auto mode.
	Home	Shortcut to return to the main screen.
	Event Log	Look over pipeline pressure logs.
	Up/Increase	<ol style="list-style-type: none"> 1. Screen scroll 2. Up cursor and increase value in setting menu.
	Down/Decrease	<ol style="list-style-type: none"> 1. Screen scroll 2. Down cursor and increase value in setting menu.
	Left	<ol style="list-style-type: none"> 1. Screen scroll; 2. Left move cursor in setting menu.
	Right	<ol style="list-style-type: none"> 1. Screen scroll 2. Right move cursor in setting menu.
	Set/Confirm	<ol style="list-style-type: none"> 1. Enter into "help" interface; 2. Pressing and holding for more than 3 seconds enters parameter configuration menu.
	Exit	<ol style="list-style-type: none"> 1. Returns to the main menu; 2. In settings menu returns to the previous menu.

⚠ WARNING: Default password is 00318, user can change it in case of others change the advanced parameters setting. Please clearly remember the password after changing. If you forget it, please contact Smartgen services and send all information in the controller page of **"ABOUT"** to us.

4.3 LCD DISPLAY

4.3.1 Main Display

Main screen is divided into left and right separate viewing areas, use  to select a viewing area; the selected area is marked with  in its upper left corner. Both viewing areas show pages; use  to scroll the pages and   to scroll the screen.

★**Home**, including as below,

1# and 2# battery charge status, simulated header, controller modes (manual, auto, shut), engine status and start status, accumulated run time, real-time clock.

★**Engine**, including as below,

Engine status, engine temperature, engine oil pressure, fuel level, battery1 voltage, battery2 voltage, charger voltage, accumulated run time, accumulated start times.

▲ **NOTE:** If connected with J1939 engine via CANBUS port, this page also includes: coolant pressure, coolant level, fuel temperature, fuel pressure, inlet temperature, exhaust temperature, turbo pressure, fuel consumption, total fuel consumption and so on. (Different engine with different parameters)

★**Pump Unit:**

Discharge pressure, pipeline pressure, pump flow, pump head, config. sensor 1~ 2 (can be set as temperature sensor, pressure sensor or level sensor)

Formula: Pump Head = (Discharge pressure - Static Pressure)/0.0098.

Pump flow is calculated according to relation curve of discharge pressure and flow; the relation curve should be set by users according to the actual usage.

★**Alarm:**

Display all warnings, shutdown alarms.

▲ **NOTE:** For ECU alarms and shutdown alarms, if the alarm information is displayed, check engine according to it, otherwise, please check the manual of generator according to SPN alarm code.

★**Event log**

Records all start/stop events (shutdown alarm, trip shutdown alarm, manual/auto start or stop) and the real time when alarm occurs.

★**Others**, including,

Time and Date, maintenance due time, input/output ports status.

★**About**, including,



Issue time of software and hardware version, product PD number.



★**Status**, including as below,

Engine speed, pipe network pressure, engine status.

Indicator	Status
Green	Normal status; No alarm
Yellow	Warning alarm occurs.
Red	Shutdown alarm occurs.

Example:

Engine	Pump 
Manual Mode Normal Running	Discharge Pressure 1.0MPa 10bar 145psi
Engine Temp 85°C 185°F	Config Sensor1 45°C 113°F
Oil Pressure 465kPa 4.65bar 67.4psi	Config Sensor2 465kPa 4.65bar 67.4psi
	Pipe Pressure 1.0MPa 10bar 145psi
Fuel Level	
 1500rpm	1.0MPa Normal Running

Engine 	Pump
Fuel Level 100%	Pipe Network Pressure 1.0MPa 10bar 145psi
Battery Voltage 1 27.6V	Pump Flow 200m³/h
Battery Voltage 2 27.6V	Pump Head 102m
Charger Voltage 28.5V	
 1500rpm	1.0MPa Emergency Stop

4.3.2 User Menu And Parameters Setting Menu

Press  to enter into user menu;

★Parameter

After entering the correct password (factory default password is 00318), you can enter into parameter settings interface.

★Language

Selectable Chinese, English and others.

★Commissioning

Commissioning can be chosen. Commission duration of runs can be set.

★Clear users' accumulation

Can clear User Accumulated Run A, User Accumulated Run B, Engine Accumulated Run time and Accumulated Start times.

Parameter setting including as following,

★Timer settings



★Engine settings



★Analog sensor settings (Engine temperature, engine oil pressure, fuel level, config. 1~2, pipe network pressure)



★Input port settings

- ★Output port settings
- ★Expansion output module
- ★Module settings
- ★Scheduling and maintenance settings





Example



Return	>Start Delay	Form1: Use   to scroll settings,  to enter settings (form2), Esc to exit settings menu.
Timers >	>Stop Delay	
Engine	>Preheat Delay	
Temp. Sensor	>Cranking Time	
OP Sensor	>Crank Rest Time	
Level Sensor	>Safety On Time	
Config Sensor 1 Config	>Start Idle Time	
Sensor 2	>Warming Up Time	
Pipe Pressure	>Cooling Time	
Discharge Press	>Stop Idle Time	
Digit Inputs	>ETS Hold Time	

Return	> Start Delay	Form 2: Use   to scroll settings (form 3),  to enter settings (form 4), Esc to return to previous menu. (form 1).
Timers >	>Stop Delay	
Engine	>Preheat Delay	
Temp. Sensor	>Cranking Time	
OP Sensor	>Crank Rest Time	
Level Sensor	>Safety On Time	
Config Sensor 1 Config	>Start Idle Time	
Sensor 2	>Warming Up Time	
Pipe Pressure	>Cooling Time	
Discharge Press	>Stop Idle Time	
Digit Inputs	>ETS Hold Time	

Return	>Start Delay	Form 3: Use   to scroll settings,  to enter settings (form4), Esc to return to previous menu. (form 1).
Timers >	>Stop Delay	
	>Preheat Delay	
Engine	> Cranking Time	
Temp. Sensor	>Crank Rest Time	
OP Sensor	>Safety On Time	
Level Sensor	>Start Idle Time	
Config Sensor 1 Config	>Warming Up Time	
Sensor 2	>Cooling Time	
Pipe Pressure	>Stop Idle Time	
Discharge Press	>ETS Hold Time	
Digit Inputs		

> Start Delay		Form 4: Press  to enter settings (form 5), Esc to return to previous menu. (form 6).
> Stop Delay	00008	
> Preheat Delay		
> Cranking Time		
> Crank Rest Time		
> Safety On Time		
> Start Idle Time		
> Warming Up Time		
> Cooling Time		
> Stop Idle Time		
> ETS Hold Time		

> Start Delay		Form5: Press   to change cursor position,   are used for changing cursor value,  Confirm setting (form 4), Esc exit setting (form 4).
> Stop Delay	00008	
> Preheat Delay		
> Cranking Time		
> Crank Rest Time		
> Safety On Time		
> Start Idle Time		
> Warming Up Time		
> Cooling Time		
> Stop Idle Time		
> ETS Hold Time		

> Start Delay		Form 6:   are used for changing the setting contents.  Confirm setting (form 4), Esc to return to previous menu. (form 1).
> Stop Delay	00008	
> Preheat Delay		
> Cranking Time		
> Crank Rest Time		
> Safety On Time		
> Start Idle Time		
> Warming Up Time		
> Cooling Time		
> Stop Idle Time		
> ETS Hold Time		
> Wait Stop Time		

▲ NOTE: Pressing  can exit setting directly during setting.

4.4 AUTO START/STOP OPERATION

When auto mode is active, auto mode will be displayed on LCD to confirm the operation.

4.4.1 Automatic Start/Stop Conditions

- 1) When Pipe Pressure is lower than set value, start automatically; when pipe pressure arrives set value, stop automatically;
- 2) When Remote Auto Start (always close) open, start automatically (only transfer to OFF mode can stop);
- 3) When Deluge Valve Start (always close) open, start automatically (only transfer to OFF mode can stop);
- 4) When Remote Manual Start (always open) close, start automatically (only transfer to OFF mode can stop);
- 5) Scheduled Start; Over Time Start; stop after operation for the set time.
- 6) Test Start, start after pressed the TEST button, stop after the operation for the set time, or press the STOP button, or stop in OFF mode.

▲ Note: After Auto Start, a, b, c, d only can overspeed alarm stop, the others only can overspeed alarm but not stop; e, f other alarm stop can occur when in operation which make Pipe Pressure lower to start by connecting to test magnetic valve.

4.4.2 Automatic Start Sequence

- 7) When satisfied the auto start conditions, "Start Delay" timer is initiated.
- 8) When start delay is over, preheat relay energizes (if configured), "preheat delay XX s" information will be displayed on LCD;
- 9) After the above delay, the Fuel Relay is energized, and then one second later, the Start Relay is engaged. The engine is cranked for a pre-set time. If the pump unit fails to fire during this cranking attempt then the fuel relay and start relay are disengaged for the pre-set rest period; "crank rest time" begins and wait for the next crank attempt.
- 10) Should this start sequence continue beyond the set number of attempts, the start sequence will be terminated, the Fail to Start fault will be displayed on LCD.
- 11) In case of successful crank attempt, the "Safety On" timer is activated, allowing Low Oil Pressure, High Temperature, Under speed and Charge Alternator Failure inputs to stabilize without triggering the fault. As soon as this delay is over, "start idle" delay is initiated (if configured).
- 12) During "start idle" delay, under speed alarm is inhibited. When this delay is over, "warming up" delay is initiated (if configured).
- 13) After the "warming up" delay, pump unit will enter into Normal Running status.



4.4.3 Automatic Stop Sequence

- 1) When satisfied the stop conditions, "Stop Delay" timer is initiated (if alarm stop, please go to step 4).
- 2) Once this "stop delay" has expired, the "Cooling Delay" is then initiated. Then the "Stop Idle" delay is initiated.
- 3) During "Stop Idle" Delay (if configured), idle relay is energized.
- 4) "ETS Solenoid Hold" begins, ETS relay is energized while fuel relay is de-energized.
- 5) "Fail to Stop Delay" begins, complete stop is detected automatically.
- 6) Pump unit is placed into its "After stop time" after its complete stop. Otherwise, fail to stop alarm is initiated and the corresponding alarm information is displayed on LCD (If pump unit stopped successfully after "Failed to Stop" alarm, it will enter "After stop time" and remove alarm).
- 7) Pump unit is placed into its standby mode after its "After stop time".



4.5 MANUAL START/STOP OPERATION

When manual mode is active, manual mode will be displayed on LCD to confirm the operation.

- 1) Manual Start: Press Start1  or Start 2  button to start the unit. Loose the button after start, and unit accelerates to high-speed running automatically. When press Start1, the unit is started via battery1; when press Start2, the unit is started via battery2.

With high temperature, low oil pressure and over speed during pump unit running, controller can protect it to stop quickly (Please refer to No.2~7 of Auto start operation for detail procedures) Start time is only 1 time. If start failed, fail alarm will be initiated.

- 2) MANUAL STOP: Press  can stop the running pump unit. (Please refer to No.2~7 of Auto stop operation for detail procedures).

If auto start condition is satisfied before shutdown, then it cannot shutdown. If shutdown is still needed, you can transfer the controller into OFF mode.

5 PROTECTION

5.1 WARNINGS

Warnings are not shutdown alarms and do not affect the operation of the genset. Warning does not lead to shutdown, and when warning condition is no longer present, warning alarm will be cleared automatically. Warning types are as follows:

No.	Type	Description
1	Over Speed	When the controller detects that the engine speed has exceeded the pre-set value, it will initiate a warning alarm.
2	Under Speed	When the controller detects that the engine speed has fallen below the pre-set value, it will initiate a warning alarm.
3	Loss of Speed Signal	When the controller detects that the engine speed is 0 and the action select "Warn", it will initiate a warning alarm.
4	Fail To Stop	After "fail to stop" delay, if unit is not stop completely, it will initiate a warning alarm.
5	Charge Alt Fail	When the controller detects that charger voltage has fallen below the pre-set value, it will initiate a warning alarm.
6	Battery 1 Over Voltage	When the controller detects that battery 1 voltage has exceeded the pre-set value, it will initiate a warning alarm.
7	Battery 1 Under Voltage	When the controller detects that battery 1 voltage has fallen below the pre-set value, it will initiate a warning alarm.
8	Maintenance Due	When maintenance countdown time is 0 and the action select "Warn", it will initiate a warning alarm.
9	ECU Warn	If an error message is received from ECU via J1939, it will initiate a warning alarm.
10	Temperature Sensor Open Circuit	When the controller detects that the temperature sensor is open circuit and the action select "Warn", it will initiate a warning alarm.
11	High Temperature	When the controller detects that engine temperature has exceeded the pre-set value, it will initiate a warning alarm.
12	Low Temperature	When the controller detects that engine temperature has fallen below the pre-set value, it will initiate a warning alarm.
13	Oil Pressure Open Circuit	When the controller detects that the oil pressure sensor is open circuit and the action select "Warn", it will initiate a warning alarm.
14	Low Oil Pressure	When the controller detects that the oil pressure has fallen below the pre-set value, it will initiate a warning alarm.
15	Level Sensor Open	When the controller detects that the level sensor is open circuit and the action select "Warn", it will initiate a warning alarm.
16	Low Fuel Level	When the controller detects that the fuel level has fallen below the pre-set value, it will initiate a warning alarm.
17	Flexible Sensor 1~2 Open	When the controller detects that the sensor is open circuit and the action select "Warn", it will initiate a warning alarm.
18	Flexible Sensor 1~2 High	When the controller detects the sensor value is higher than the max. set value, it will initiate a warning alarm.
19	Flexible Sensor 1~2 Low	When the controller detects the sensor value is lower than the min. set value, it will initiate a warning alarm.



No.	Type	Description
20	Digital Input 1~8 Warn	When the action of digital input port select "Warn" and active, it will initiate a warning alarm.
21	Battery 2 Over Voltage	When the controller detects that battery 2 voltage has exceeded the pre-set value, it will initiate a warning alarm.
22	Battery 2 Under Voltage	When the controller detects that battery 2 voltage has fallen below the pre-set value, it will initiate a warning alarm.
23	Pipe Pressure Sensor Open	When the controller detects that the pipe pressure sensor is open circuit and the action select "Warn", it will initiate a warning alarm.
24	Pipe Pressure Sensor High	When the controller detects the sensor value is higher than the max. set value, it will initiate a warning alarm.
25	Pipe Pressure Sensor Low	When the controller detects the sensor value is lower than the min. set value, it will initiate a warning alarm.
26	Discharge Pressure Sensor Open	When the controller detects that the discharge pressure sensor is open circuit and the action select "Warn", it will initiate a warning alarm.
27	Discharge Pressure Sensor High	When the controller detects the sensor value is higher than the max. set value, it will initiate a warning alarm.
28	Discharge Pressure Sensor Low	When the controller detects the sensor value is lower than the min. set value, it will initiate a warning alarm.
29	Over Flow Warn	When the controller detects the flow value is higher than the max. set value, it will initiate a warning alarm.
30	End Of The Mandate	When the mandate time has expired and the action select "Warn", it will initiate a warning alarm.
31	Output-Mod Com Fail	When the expansion module which is circumscribed by CAN port communication fails, it will initiate a warning alarm.
32	Charger1 AC Fail	When the charger1 detects utility failure, it will initiate a warning alarm.
33	Charger2 AC Fail	When the charger2 detects utility failure, it will initiate a warning alarm.
34	Charger1 Com. Fail	When the controller cannot communicate with charger1 normally, it will initiate a warning alarm.
35	Charger2 Com. Fail	When the controller cannot communicate with charger2 normally, it will initiate a warning alarm.
36	Charger1 Charging Fail	When the charger1 cannot charge the battery normally, it will initiate a warning alarm.
37	Charger2 Charging Fail	When the charger2 cannot charge the battery normally, it will initiate a warning alarm.
38	Low Suction	When low suction is active, it will initiate a warning alarm.
39	Water Reservoir Low	When water reservoir low is active, it will initiate a warning alarm.
40	Water Reservoir Empty	When water reservoir empty is active, it will initiate a warning alarm.



5.2 SHUTDOWN ALARM

When controller detects shutdown alarm, it will send signal to open breaker and stop the unit. Shutdown alarm must be cleared manually and the fault removed to reset the module. Shutdown alarm types are as follows:

NO.	Type	Description
1	Emergency Stop	When the controller detects an emergency stop alarm signal, it will initiate a shutdown alarm.
2	Over Speed	When the controller detects that the generator speed has exceeded the pre-set value, it will initiate a shutdown alarm.
3	Under Speed	When the controller detects that the generator speed has fallen below the pre-set value, it will initiate a shutdown alarm.
4	Loss of Speed Signal	When the controller detects that the engine speed is 0 and the action select "Warn", it will initiate a shutdown alarm.
5	Maintenance Due	When maintenance countdown time is 0 and the action select "Shutdown", it will initiate a shutdown alarm.
6	ECU Shutdown	If shutdown alarm signal is received from ECU via J1939, it will initiate a shutdown alarm.
7	ECU Fail	If the module does not detect the J1939 data, it will initiate a shutdown alarm.
8	Temperature Sensor Open Circuit	When the controller detects that the temperature sensor is open circuit and the action select "Shutdown", it will initiate a shutdown alarm.
9	High Temperature	When the controller detects that engine temperature has exceeded the pre-set value, it will initiate a shutdown alarm.
10	Oil Pressure Open Circuit	When the controller detects that the oil pressure sensor is open circuit and the action select "Shutdown", it will initiate a shutdown alarm.
11	Low Oil Pressure	When the controller detects that the oil pressure has fallen below the pre-set value, it will initiate a shutdown alarm.
12	Level Sensor Open Circuit	When the controller detects that the sensor is open circuit and the action select "Shutdown", it will initiate a shutdown alarm.
13	Flexible Sensor 1~2 Open	When the controller detects that the sensor is open circuit and the action select "Shutdown", it will initiate a shutdown alarm.
16	Flexible Sensor 1~2 High	When the controller detects the sensor value is higher than the max. set value, it will initiate a shutdown alarm.
17	Flexible Sensor 1~2 Low	When the controller detects the sensor value is lower than the min. set value, it will initiate a shutdown alarm.
18	Digital Input 1~8 Shutdown	When the action of digital input port select "Shutdown" and active, it will initiate a shutdown alarm.
19	Pipe Pressure Sensor Open	When the controller detects that the pipe pressure sensor is open circuit and the action select "Shutdown", it will initiate a shutdown



NO.	Type	Description
		alarm.
20	Pipe Pressure Sensor High	When the controller detects the sensor value is higher than the max. set value, it will initiate a shutdown alarm.
21	Pipe Pressure Sensor Low	When the controller detects the sensor value is lower than the min. set value, it will initiate a shutdown alarm.
22	Discharge Pressure Sensor Open	When the controller detects that the discharge pressure sensor is open circuit and the action select "Shutdown", it will initiate a shutdown alarm.
23	Discharge Pressure Sensor High	When the controller detects the sensor value is higher than the max. set value, it will initiate a shutdown alarm.
24	Discharge Pressure Sensor Low	When the controller detects the sensor value is lower than the min. set value, it will initiate a shutdown alarm.
25	Over Flow Shutdown	When the controller detects the flow value is higher than the max. set value, it will initiate a shutdown alarm.
26	Output-Mod Com Fail	When the controller's communication with expansion module fails, it will initiate a warning alarm.

5.3 INDICATION

On initiation of the indication alarm the controller does not perform any action, and the alarm information will be displayed on Alarm page.

Indication alarm types are as follows:

No.	Type	Description
1	Maintain Over Time	When maintenance countdown time is 0 and the action select "Indication", it will initiate a indication alarm.
2	Digital Input 1~8	When the action of digital input port select "Indication" and active, it will initiate a indication alarm.

6 CONNECTIONS

FPC915 controller back panel is shown below:

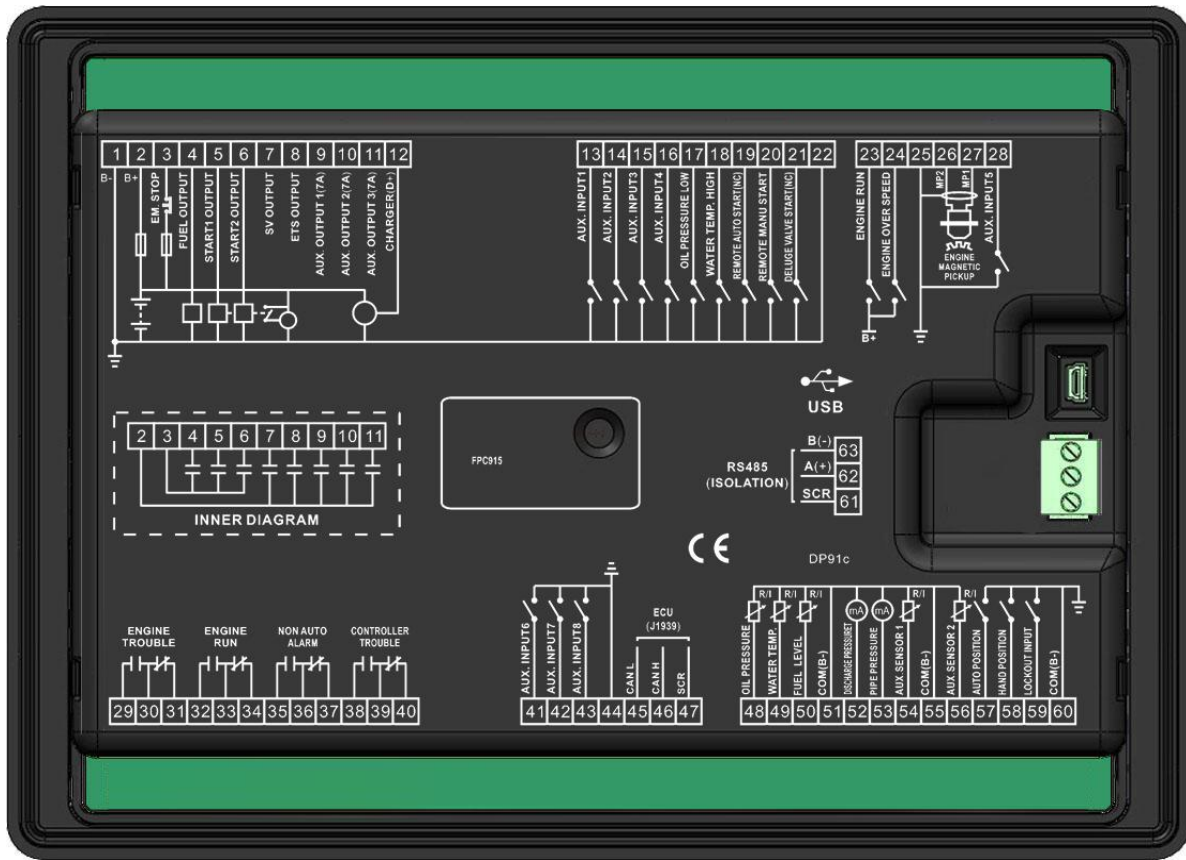

Description of terminal connections:

Pin	Function	Cable Size	Description	
1	B-	2.5mm ²	Connected with negative of starter battery.	
2	B+	2.5mm ²	Connected with positive of starter battery. If wire length is over 30m, better to double wires in parallel. Max. 20A fuse is recommended.	
3	Emergency Stop	2.5mm ²	Connected with B+ power supply via emergency stop button.	
4	Fuel Relay Output	1.5mm ²	B+ power is supplied by terminal 3, rated 16A	
5	Start Relay1 Output	1.5mm ²	B+ power is supplied by terminal 3, rated 16A	Control the starter via battery1.
6	Start Relay2 Output	1.5mm ²	B+ power is supplied by terminal 3, rated 16A	Control the starter via battery1.
7	SV Output	1.5mm ²	B+ power is supplied by terminal 2, rated 7A	
8	ETS Output	1.5mm ²	B+ power is supplied by terminal 2, rated 7A	
9	Aux. Output 1	1.5mm ²	B+ power is supplied by terminal 2, rated 7A	Details see form 2
10	Aux. Output 2	1.5mm ²	B+ power is supplied by terminal 2, rated 7A	



Pin	Function	Cable Size	Description	
11	Aux. Output 3	1.5mm ²	B+ power is supplied by terminal 2, rated 7A	
12	Charger(D+)	1.0mm ²	Connected with charger starter's D+ (WL) terminals. Being hang up If there is no this terminal.	
13	Aux. Input 1	1.0mm ²	Ground connected is active (B-)	Details see form 3
14	Aux. Input 2	1.0mm ²	Ground connected is active (B-)	
15	Aux. Input 3	1.0mm ²	Ground connected is active (B-)	
16	Aux. Input 4	1.0mm ²	Ground connected is active (B-)	
17	Oil Pressure Low	1.0mm ²	Ground connected is active (B-)	
18	Water Temp. High	1.0mm ²	Ground connected is active (B)	
19	Remote Auto Start	1.0mm ²	Ground connected is inactive (B-), but hanging.	
20	Remote Manu Start	1.0mm ²	Ground connected is active (B-)	
21	Deluge Valve Start	1.0mm ²	Ground connected is inactive (B-), but hanging.	
22	Common GND(B-)	1.0mm ²	(B-) has already connected innerly.	
23	Engine Run	1.0mm ²	Connection to positive (B+) is active.	
24	Over Speed	1.0mm ²		
25	Magnetic Pickup / GND		(B-) has already connected with ground innerly.	
26	Engine Magnetic Pickup 2	0.5mm ²	Connected with Engine Speed Sensor, shielding line is recommended. (B-) has already connected with speed sensor innerly.	
27	Engine Magnetic Pickup 1			
28	Aux. Input 5	1.0mm ²	Ground connected is active (B-)	
29	Engine Trouble	1.5mm ²	Normally close output, rated 7A	Output when overspeed shutdown, failed to start, oil pressure low and water temperature high shutdown alarms
30			Public points of relay	
31			Normally open output, rated 7A	
32	Engine Run	1.5mm ²	Normally close output, rated 7A	Output when genset runs
33			Public points of relay	
34			Normally open output, rated 7A	
35	Non Auto Alarm	1.5mm ²	Normally close output, rated 7A	Output when controller is in manual/OFF mode
36			Public points of relay	
37			Normally open output, rated 7A	
38	Controller Trouble	1.5mm ²	Normally close output, rated 7A	Output when common alarms
39			Public points of relay	
40			Normally open output, rated 7A	
41	Aux. Input 6	1.0mm ²	Ground connected is active (B-)	
42	Aux. Input 7	1.0mm ²	Ground connected is active (B-)	



Pin	Function	Cable Size	Description
43	Aux. Input8	1.0mm ²	Ground connected is active (B-)
44	Common GND(B-)	1.0mm ²	(B-) has already connected innerly.
45	ECU CAN L	0.5mm ²	Impedance-120Ω shielding wire is recommended, its single-end earthed. 120Ω matched resistance has already connected internally.
46	ECU CAN H	0.5mm ²	
47	ECU CAN COM	/	
48	Oil pressure sensor	1.0mm ²	Connected to oil pressure sensor
49	Temperature sensor	1.0mm ²	Connected to temperature sensor
50	Fuel level sensor	1.0mm ²	Connected to fuel level sensor
51	Sensor COM 1	1.0mm ²	Public terminal of sensor, (B-) has already connected.
52	Discharge Pressure Sensor	1.0mm ²	Pump sensor
53	Pipe Pressure Sensor	1.0mm ²	
54	Aux. sensor 1	1.0mm ²	Spare sensor of pump unit
55	Sensor COM 2	1.0mm ²	Public terminal of sensor, (B-) has already connected.
56	Aux. sensor 2	1.0mm ²	Spare sensor of pump unit
57	Auto Position	1.0mm ²	Connected to panel electric lock, chose the work mode for controller.
58	Hand Position	1.0mm ²	
59	Lockout Input	1.0mm ²	The genset won't auto start if the genset didn't start when lockout input is active.
60	Common (B-)	1.0mm ²	(B-) has already connected innerly.
61	RS485	/	Impedance-120Ω shielding wire is recommended, its single-end earthed.
62	RS485+	0.5mm ²	
63	RS485-	0.5mm ²	

NOTE: USB ports in controller rear panel are programmable parameter ports, user can directly configure controller via PC in stop mode.

7 DEFINITION AND RANGE OF PARAMETERS

7.1 PARAMETER CONTENTS AND RANGE (FORM 1)

No.	Items	Parameter	Default	Description
Timer Setting				
1	Start Delay	(0-3600)s	1	Time from remote start signal is active to start the pump unit.
2	Return Delay	(0-3600)s	1	Time from remote stop signal is deactivated to stop the pump unit.
3	Preheat Delay	(0-3600)s	0	Time of pre-powering heat plug before starter is powered up.
4	Cranking Time	(3-60)s	8	Time of starter power up
5	Crank Rest Time	(3-60)s	10	The waiting time before second power up when engine start fail.
6	Safety On Delay	(0-3600)s	10	Alarms for low oil pressure, high temperature, under speed, under frequency/voltage, charge fail are inactive.
7	Start Idle Time	(0-3600)s	0	Idle running time of the pump unit when starting.
8	Warming Up Time	(0-3600)s	10	Warming time between the pump unit take load and high speed running.
9	Cooling Time	(0-3600)s	0	Radiating time before stop the pump unit, after it unloads.
10	Stop Idle Time	(0-3600)s	0	Idle running time when pump unit stop.
11	ETS Hold Hold	(0-3600)s	20	Stop electromagnet's power on time when pump unit is stopping.
12	Fail to Stop Delay	(0-3600)s	0	Time between ending of pump unit idle delay and stopped when "ETS time" is set as 0; Time between ending of ETS hold delay and stopped when "ETS Hold output time" is not 0.
13	After Stop Time	(0-3600)s	0	Time between pump unit stopped and standby.
Engine Setting				
1	Engine Type	(0-39)	0	Default: Conventional genset (not J1939) When connected to J1939 engine, choose the corresponding type.
2	Flywheel Teeth	(10-300)	118	Tooth number of the engine, for judging of starter separation conditions and inspecting of engine speed. See the following Installation Instruction.
3	Rated Speed	(0-6000)r/min	1500	Offer standard to judge over/under/loading speed.
4	Loss of Speed Signal	(0-3600)s	5	Time from detecting speed is 0 to confirm the action.
5	Loss of Speed Action	(0-1)	0	0:Warn; 1:Shutdown
6	Over Speed Shutdown	(0-200)%	114%	Setting value is percentage of rated speed and delay value can be set.



No.	Items	Parameter	Default	Description
7	Under Speed Shutdown	(0-200)%	80%	
8	Over Speed Warn	(0-200)%	110%	Setting value is percentage of rated speed. Delay value and return value can be set.
9	Under Speed Warn	(0-200)%	86%	
10	Battery 1 Rated Voltage	(0-60.0)V	24.0	Standard for detecting over/under voltage of battery.
11	Battery 1 Over Volts	(0-200)%	120%	Setting value is percentage of rated voltage of battery. Delay value & return value can be set.
12	Battery 1 Under Volts	(0-200)%	85%	
13	Battery 2 Rated Voltage	(0-60.0)V	24.0	Standard for detecting over/under voltage of battery.
14	Battery 2 Over Volts	(0-200)%	120%	Setting value is percentage of rated voltage of battery. Delay value & return value can be set.
15	Battery 2 Under Volts	(0-200)%	85%	
16	Charge Alt Fail	(0-60.0)V	8.0	In normal running, when charger D+(WL) voltage under this value, charge failure alarms.
17	Start Attempts	(1-10) times	3	Max. Crank times of crank attempts. When reach this number, controller will send start failure signal.
18	Crank Disconnect	(0-6)	2	See form 5. There are 3 conditions of disconnecting starter with engine. Each condition can be used alone and simultaneously to separating the start motor and genset as soon as possible.
19	Disconnect Engine Speed	(0-1000)%	24%	Setting value is percentage of rated speed. When engine speed is higher than the set value, starter will be disconnected. See the following Installation Instruction.
20	Disconnect OP	(0-1000)kPa	200	When generator oil pressure is higher than the set value, starter will be disconnected. See the following Installation Instruction.
Module Setting				
1	Module Address	(1-254)	1	Controller's address during remote sensing.
2	Stop Bits	(0-1)	0	0: 2 stop bits; 1: 1 stop bit
3	Language	(0-2)	0	0: Simplified Chinese 1: English 2: Others
4	Password	(0-65535)	00318	For entering advanced parameters setting.
5	Time and Date			User set
Scheduling And Maintenance Setting				
1	Scheduled Run	(0-1)	0	0: Disable; 1: Enable
2	Scheduled Not	(0-1)	0	0: Disable; 1: Enable



No.	Items	Parameter	Default	Description
	Run			
3	Maintenance 1	(0-1)	0	0: Disable; 1: Enable Users can set maintenance time, maintenance due action, prealarm A, prealarm B, timer mode and reset maintenance alarm. If maintenance due alarm occurs, users can reset maintenance alarm to remove it.
4	Maintenance 2	(0-1)	0	
5	Maintenance 3	(0-1)	0	
6	Maintenance 4	(0-1)	0	
7	Maintenance 5	(0-1)	0	
Analog Sensors Setting				
Temperature Sensor				
1	Curve Type	(0-15)	7	SGX. See form 5.
2	Open Action	(0-2)	0	0: Warn; 1: Shutdown; 2: No action
3	High Temp. Shutdown	(0~300)°C	98	Shutdown when external sensor temperature is higher than this value. Detecting only after safety delay is over. The delay value can be set.
4	High Temp. Warn	(0~300)°C	95	Warn when external sensor temperature is higher than this value. Detecting only after safety delay is over. The delay value and return value can be set.
5	Low Temp. Warn	(0-1)	0	0: Disable; 1: Enable
6	Custom Curve			Users should set the corresponding curve when select resistor curve type or current curve type.
Oil Pressure Sensor				
1	Curve Type	(0-15)	7	SGX. See form 5.
2	Open Action	(0-2)	0	0: Warn; 1: Shutdown; 2: No action
3	Low OP Shutdown	(0-1000)kPa	103	Shutdown when external oil pressure is lower than this value. Detecting only after safety delay is over. The delay value can be set.
4	Low OP Warn	(0-1000)kPa	124	Warn when external oil pressure is higher than this value. Detecting only after safety delay is over. The delay value and return value can be set.
5	Custom Curve			Users should set the corresponding curve when select resistor curve type or current curve type.
Liquid Level Sensor				
1	Curve Type	(0-15)	4	SGH. See form 5.
2	Open Action	(0-2)	0	0:Warn; 1:Shutdown; 2:No action
3	Low Level Warn	(0-1000)%	10	Warn when external level is lower than this value. It is detecting all the time. The delay value and return value can be set.
4	Custom Curve			Users should set the corresponding curve when select resistor curve type or current curve type.
Flexible Sensor 1~2				
1	Flexible Sensor Setting	(0-1)	0	0: Disable ; 1: Enable (can be set as temperature/oil pressure/liquid lever sensor)



No.	Items	Parameter	Default	Description
2	Curve Type			Depends on sensor type.
3	Open Action	(0-2)	0	0:Warn; 1:Shutdown; 2:No action
4	High Shutdown	(0-9000)	100	Shutdown when external sensor value is higher than this value. The delay value and “warn enable” can be set.
5	Low Shutdown	(0-9000)	10	Shutdown when external sensor value is lower than this value. The delay value and “warn enable” can be set.
6	High Warn	(0-9000)	90	Warn when external sensor value is higher than this value. The delay value, “warn enable” and return value can be set.
7	Low Warn	(0-9000)	20	Warn when external sensor value is lower than this value. The delay value, “warn enable” and return value can be set.
8	Custom Curve			Users should set the corresponding curve when select resistor curve type or current curve type.
Pipe Pressure Sensor				
1	Curve Type	(0-15)	2	
2	Open Action	(0-2)	1	0:Warn; 1:Shutdown; 2:No action
3	Over Stop	(0-9000)	1000	Shutdown when external sensor value is over this value. The delay value and “warn enable” can be set.
4	Under Start	(0-9000)	600	Shutdown when external sensor value is under this value. The delay value and “warn enable” can be set.
5	Over Warn	(0-9000)	1200	Warn when external sensor value is over this value. The delay value, “warn enable” and return value can be set.
6	Under Warn	(0-9000)	200	Warn when external sensor value is under this value. The delay value, “warn enable” and return value can be set.
7	Custom Curve			Users should set the corresponding curve when select resistor curve type or current curve type.
Discharge Pressure Sensor				
1	Curve Type	(0-15)	2	
2	Open Action	(0-2)	1	0:Warn; 1:Shutdown; 2:No action
3	High Shutdown	(0-9000)%	80	Shutdown when external sensor value is higher than this value. The delay value and “warn enable” can be set.
4	Low Shutdown	(0-9000)%	50	Shutdown when external sensor value is lower than this value. The delay value and “warn enable” can be set.
5	High Warn	(0-9000)%	110	Warn when external sensor value is higher than this value. The delay value, “warn enable” and



No.	Items	Parameter	Default	Description
				return value can be set.
6	Low Warn	(0-9000)%	20	Warn when external sensor value is lower than this value. The delay value, "warn enable" and return value can be set.
7	Custom Curve			Users should set the corresponding curve when select resistor curve type or current curve type.
8	Rated Discharge Pressure	(0-9000)kPa	1000	Set the discharge port's rated working pressure of pump unit.
9	Static Pressure	(0-9000)kPa	0	Set the discharge port's static pressure of pump unit.
10	Flow Function	(0-1)	0	0: Disable; 1: Enable
11	Rated Flow	(0-10000)m ³ /h	1000	Pump unit's rated working pressure.
12	Over Flow Warn	(0-1000)%	110	During normal running process, it will initiated a warning alarm signal when flow value has exceed the set value. The delay value, "warn enable" and return value can be set.
13	Over Flow Shut	(0-1000)%	120	During normal running process, it will initiate a shutdown alarm signal when flow value has exceeded the set value. The "warn enable" and delay value can be set.
14	Flow Curve			Different discharge pressures correspond to different flow value.
Flexible Input Ports				
Flexible Input Port 1				
1	Contents Setting	(0-30)	21	Remote start (on load).
2	Active Type	(0-1)	0	0: Closed to active 1: Open to active
Flexible Input Port 2				
1	Contents Setting	(0-30)	22	High temperature shutdown.
2	Active Type	(0-1)	0	0: Closed to active 1: Open to active
Flexible Input Port 3				
1	Contents Setting	(0-30)	23	Low oil pressure shutdown.
2	Active Type	(0-1)	0	0: Closed to active 1: Open to active
Flexible Input Port 4				
1	Contents Setting	(0-30)	24	User defined.
2	Active Type	(0-1)	0	0: Closed to active 1: Open to active
Flexible Input Port 5				
1	Contents Setting	(0-30)	25	User defined.
2	Active Type	(0-1)	0	0: Closed to active 1: Open to active
Flexible Input Port 6				
1	Contents Setting	(0-30)	26	User defined.
2	Active Type	(0-1)	0	0: Closed to active 1: Open to active
Flexible Input Port 7				
1	Contents Setting	(0-30)	0	Lamp Test. See form 3.
2	Active Type	(0-1)	0	0: Closed to active 1: Open to active



No.	Items	Parameter	Default	Description
3	Arming	(0-3)	2	0: From safety on 1: From starting 2: Always 3:Never
4	Active Actions	(0-4)	2	0: Warn; 1: Shutdown; 2: Indication
5	Active Delay	(0-20.0)s	2.0	Time from detecting active to confirm.
6	Description			User defined.
Flexible Input Port 8				
1	Contents Setting	(0-30)	0	User defined. See form 3.
2	Active Type	(0-1)	0	0: Closed to active 1: Open to active
3	Arming	(0-3)	0	0: From safety on 1: From starting 2: Always 3:Never
4	Active Actions	(0-4)	0	0: Warn; 1: Shutdown; 2: Indication
5	Active Delay	(0-20.0)s	2.0	Time from detecting active to confirm.
6	Description			User defined.
Flexible Output Ports				
Flexible Output Port 1				
1	Contents Setting	(0-239)	1	User defined period output (default output is in preheating) See form 4.
2	Active Type	(0-1)	0	0:Normally open; 1:Normally close
Flexible Output Port 2				
1	Contents Setting	(0-239)	35	Idle speed control. See form 4.
2	Active Type	(0-1)	0	0:Normally open; 1:Normally close
Flexible Output Port 3				
1	Contents Setting	(0-239)	29	Reserved. See form 4.
2	Active Type	(0-1)	0	0:Normally open; 1:Normally close

7.2 PROGRAMMABLE OUTPUT

7.2.1 Programmable Output 1-5 (Form 2)

No.	Type	Description
0	Not Used	
1	Custom Period 1	Details of function description please see the following.
2	Custom Period 2	
3	Custom Period 3	
4	Custom Period 4	
5	Custom Period 5	
6	Custom Period 6	
7	Custom Combined 1	
8	Custom Combined 2	
9	Custom Combined 3	
10	Custom Combined 4	
11	Custom Combined 5	
12	Custom Combined 6	
13	Reserved	
14	Reserved	
15	Reserved	
16	Start Relay B	Start via battery2. Action in genset starting and disconnect when genset start completely.
17	Air Flap Control	Action when over speed shutdown and emergence stop. It can close the air inflow to stop the engine as soon as possible.
18	Audible Alarm	Action when warning or shutdown occurs. Can be connected annunciator externally. When "alarm mute" input port is active, the alarm will be prohibit.
19	Louver Control	Action in genset starting and disconnect when genset stopped completely.
20	Fuel Pump Control	It is controlled by fuel pump of level sensor's limited threshold.
21	Heater Control	It is controlled by heating of temperature sensor's limited threshold.
22	Cooler Control	It is controlled by cooler of temperature sensor's limited threshold.
23	Fuel Pre-supply	Actions in period of cranking to safety run.
24	Reserved	
25	Pre-Lubricate	Actions in period of pre-heating to safety run.
26	Remote PC Output	This port is controlled by RS485 communication (PC).
27	Reserved	
28	Reserved	
29	Reserved	
30	Reserved	
31	Reserved	
32	Reserved	



33	Crank RelayA	Start via battery1. Action in genset starting and disconnect when genset start completely.
34	Fuel Relay	Action when genset is starting and disconnect when stop is completed.
35	Idle Control	Used for engine which has idles. Close before starting and open in warming up delay; Close during stopping idle process and open when stop is completed.
36	Speed Raise Relay	Action in warming up delay and be controlled by GOV in normal running process.
37	Speed Drop Relay	Action between the period from “stop idle” to “failed to stop” and be controlled by GOV in normal running process.
38	Energise to Stop	Used for engines with ETS electromagnet. Close when stop idle is over and open when pre-set “ETS delay” is over.
39	Speed Drop Pulse	Active 0.1s when controller enter into stop idle, used for control part of ECU dropping to idle speed (temporary reserved).
40	ECU Stop	Suitable for engines which fitted with ECU; used for control ECU stop.
41	ECU Power Supply	Suitable for engines which fitted with ECU; used for control ECU power supply.
42	Speed Raise Pulse	Active 0.1s when controller enters into warming up delay; used for control part of ECU raising to normal speed (temporary reserved).
43	Crank Success	Close when detects a successful start signal.
44	Reserved	
45	Reserved	
46	Reserved	
47	Reserved	
48	Common Alarm	Action when pump unit common warning, common shutdown alarm.
49	Reserved	
50	Common Shutdown	Action when common shutdown alarm.
51	Reserved	
52	Common Warn Alarm	Action when common warning alarm.
53	Reserved	
54	Battery 1 High Volt	Action when battery 1 over voltage warning alarm.
55	Battery 1 Low Volt	Action when battery 1 low voltage warning alarm.
56	Charge Alt Fail	Action when charge failure warning alarms.
57	Reserved	
58	Reserved	
59	Reserved	
60	ECU Warn	Indicate ECU sends a warning signal.
61	ECU Shutdown	Indicate ECU sends a shutdown signal.
62	ECU COM Fail	Indicate controller cannot communicate with ECU.
63	Reserved	
64	Reserved	



65	Reserved	
66	Reserved	
67	Reserved	
68	Reserved	
69	Aux Input 1 Active	Action when input port 1 is active.
70	Aux Input 2 Active	Action when input port 2 is active.
71	Aux Input 3 Active	Action when input port 3 is active.
72	Aux Input 4 Active	Action when input port 4 is active.
73	Aux Input 5 Active	Action when input port 5 is active.
74	Aux Input 6 Active	Action when input port 6 is active.
75	Aux Input 7 Active	Action when input port 7 is active.
76	Aux Input 8 Active	Action when input port 8 is active.
77-96	Reserved	
97	Battery 2 High Volt	Action when battery 2 over voltage warning alarm.
98	Battery 2 Low Volt	Action when battery 2 low voltage warning alarm.
99	Emergency Stop	Action when emergency stop alarm.
100	Fail To Start	Action when failed start alarm.
101	Fail To Stop	Action when failed stop alarm.
102	Under Speed Warn	Action when under speed alarm.
103	Under Speed Shutdown	Action when under speed shuts down.
104	Over Speed Warn	Action when over speed warning.
105	Over Speed Shutdown	Action when over speed shutdown alarm.
106-138	Reserved	
139	Engine H Temp Warn	Action when high temperature warning.
140	Engine L Temp Warn	Action when low temperature warning.
141	Engine HT Shutdown	Action when hi-temperature Shutdown alarm.
142	Reserved	
143	Engine Low OP Warn	Action when low oil pressure warning.
144	Eng LOP Shutdown	Action when low oil pressure shutdown.
145	OP Sensor Open	Action when oil pressure sensor is open circuit.
146	Reserved	
147	Low Level Warn	Action when low oil level warning.
148	Over Flow Shutdown	Action when low oil pressure shutdown.
149	Over Flow Warn	Action when low oil pressure warning.
150	Config 1 High Warn	
151	Config 1 Low Warn	
152	Config 1 High Shut	
153	Config 1 Low Shut	
154	Config 2 High Warn	
155	Config 2 Low Warn	
156	Config 2 High Shut	
157	Config 2 Low Shut	
158	Reserved	
159	Reserved	



160	Reserved	
161	Reserved	
162	Reserved	
163	Reserved	
164	Reserved	
165	Reserved	
166	Reserved	
167	Reserved	
168	Reserved	
169	Reserved	
170	Pipe Press High Warn	
171	Pipe Press Low Warn	
172	Reserved	
173	Reserved	
174	Discharge High Warn	
175	Discharge Low Warn	
176	Discharge High Shut	
177	Discharge Low Shut	
178~229	Reserved	
230	In OFF Mode	Action in stop mode.
231	In Manual Mode	Action in Manual mode.
232	Reserved	
233	In Auto Mode	Action in Auto mode.
234~239	Reserved	

7.2.2 Custom Period Output

Defined Period output is composed by 2 parts, period output S1 and condition output S2.



While S1 and S2 are **TRUE** synchronously, OUTPUT;

While S1 or S2 is **FALSE**, NOT OUTPUT.

Period output S1, can set pump unit's one or more period output freely, can set the delayed time and output time after enter into period.

Condition output S2; can set as any conditions in output ports.

▲ NOTE: when delay time and output time both are 0 in period output S1, it is **TRUE** in this period.

Example,

Output period: start

Delay output time: 2s

Output time: 3s

Condition output contents: output port 1 is active

Close when condition output active/inactive: close when active (disconnect when inactive);

Output port 1 active, after enter "starts time" and delay 2s, this defined period output is outputting, after 3s, stop outputting;

Output port 1 inactive, defined output period is not outputting



7.2.3 Custom Combined Output

Defined combination output is composed by 3 parts, condition output S1/S2 and condition output S3.

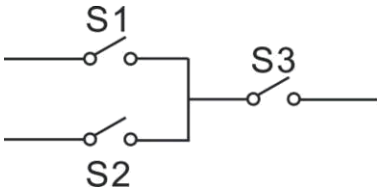

S1 or S2 is **TRUE**, while S3 is **TRUE**, Defined combination output is outputting;

S1 and S2 are **FALSE**, or S3 is **FALSE**, Defined combination output is not outputting.

▲NOTE: S1, S2, S3 can be set as any contents except for “defined combination output” in the output setting.

▲NOTE: 3 parts of defined combination output (S1, S2, S3) couldn't include or recursively include themselves.

Example,

Contents of probably condition output S1: output port 1 is active;

Close when probably condition output S1 is active /inactive: close when active (disconnect when inactive);

Contents of probably condition output S2, output port 2 is active;

Close when probably condition output S2 is active /inactive: close when active (disconnect when inactive);

Contents of probably condition output S3: output port 3 is active;

Close when probably condition output S3 is active /inactive: close when active (disconnect when inactive);

When input port 1 active or input port 2 active, if input port 3 is active, Defined combination output is outputting; If input port 3 inactive, Defined combination output is not outputting;

When input port 1 inactive and input port 2 inactive, whatever input port 3 is active or not, Defined combination output is not outputting.



7.3 DEFINED CONTENTS OF CONFIGURABLE INPUT PORTS (ALL ACTIVE WHEN CONNECT TO GRAND (B-))(FORM3)

No.	Type	Description
0	Users Configured	Including following functions, Indication: indicate only, not warning or shutdown. Warning: warn only, not shutdown. Shutdown: alarm and shutdown immediately Never: input inactive. Always: input is active all the time. From crank: detecting as soon as start. From safety on: detecting after safety on run delay.
1	Reserved	
2	Alarm Mute	Can prohibit "Audible Alarm" output when input is active.
3	Alarm Reset	Can reset shutdown alarm when input is active.
4	Reserved	
5	Lamp Test	All LED indicators are illuminating when input is active.
6	Reserved	
7	Reserved	
8	Idle Speed Active	Under speed protection is inactive.
9	Reserved	
10	Reserved	
11	Scheduled Run Inhibit	In Auto mode, inhibit pump unit scheduled run when input is active.
12	Reserved	
13	Reserved	
14	Instrument Mode	All inputs are inhibited in this mode.
15	Reset Maintenance	The controller will set maintenance time and date to default when input is active.
16	Reserved	
17	Reserved	
18	Reserved	
19	Reserved	
20	Reserved	
21	Low Suction	Low suction alarm input.
22	Water Reservoir Low	Water reservoir low alarm input.
23	Water Reserv. Empty	Water reservoir empty alarm input.
24	Low Pump Room Temp	Low pump room temp alarm input.
25	Low Fuel Level	Low fuel level alarm input.
26	High Fuel Level	High fuel level alarm input.
27	Reserved	
28	Reserved	
29	Reserved	
30	Reserved	



7.4 SELECTION OF SENSORS (FORM4)

No.	Type	Description	Remark
1	Temperature Sensor	0 Not used 1 Custom Res Curve 2 Custom 4-20mA curve 3 VDO 4 CURTIS 5 VOLVO-EC 6 DATCON 7 SGX 8 SGD 9 SGH 10 PT100 11~15 Reserved	Defined resistance's range is (0~6)KΩ, default is SGX sensor.
2	Pressure Sensor	0 Not used 1 Custom Res Curve 2 Custom 4-20mA curve 3 VDO 10bar 4 CURTIS 5 VOLVO-EC 6 DATCON 10bar 7 SGX 8 SGD 9 SGH 10~15 Reserved	Defined resistance's range is (0~6)KΩ, default is SGX sensor.
3	Fuel Level Sensor	0 Not used 1 Custom Res Curve 2 Custom 4-20mA curve 3 SGD 4 SGH 5~15 Reserved	Defined resistance's range is (0~6)KΩ, default is SGH sensor.

▲Note: User should take the controller apart to change the jumper hat from resistor side to current side if your pump unit fitted with 4~20mA sensor.

7.5 CONDITIONS OF CRANK DISCONNECT SELECTION (FORM5)

No.	Setting description
0	AUX.IN
1	Speed
2	Speed + AUX.IN
3	Oil Pressure
4	OP + AUX.IN
5	OP + Speed
6	OP + Speed + AUX.IN

▲ NOTE:

- 1) There are 3 conditions to make starter disconnected with engine. Auxiliary input, engine speed and oil pressure both can be used separately. We recommend that oil pressure should be using with engine speed together, in order to make the starter motor is separated with engine immediately and can check crank disconnect exactly.
- 2) Engine speed is the magnetic equipment which be installed in starter for detecting flywheel teeth.
- 3) When set as engine speed, must ensure that the number of flywheel teeth is as same as setting, otherwise, "over speed shutdown" or "under speed shutdown" may be caused.
- 4) If pump unit without engine speed sensor, please don't select corresponding items, otherwise, "start fail" or "loss speed signal" maybe caused.
- 5) If genset without oil pressure sensor, please don't select corresponding items.

7.6 MAINTENANCE (FORM 6)

Items	Content	Description
Enable Select	0: Disable; 1: Enable	Used for setting the current maintenance function.
Maintenance Interval	(0-30000)h	The time interval between two maintenance.
Maintenance Due	0: No Action; 1: Warn; 2: Shutdown; 3: Indication.	They are the alarm action types when the maintenance time is due.
Prealarm A	(0-30000)h	Maintenance remaining time
Prealarm A Action	0: No Action; 1: Warn; 2: Shutdown; 3: Indication.	They are the alarm action types when the maintenance remaining time is left prealarm A time only.
Prealarm B	(0-30000)h	Maintenance remaining time
Prealarm B Action	0: No Action; 1: Warn; 2: Shutdown; 3: Indication.	They are the alarm action types when the maintenance remaining time is left prealarm B time only.
Timer Mode	0: Running Time; 1: Real Time Clock	The maintenance timer mode
Reset Maintenance Alarm		Reset maintenance alarm when the maintenance time is due.
Description		The maintenance name are user-set. E.g. Change oil

⚠ CAUTION: Please change the controller parameters when generator is in standby mode only (e. g. Crank disconnect conditions selection, digital input, digital output, various delay), otherwise, shutdown and other abnormal conditions may occurs.

⚠ NOTE: Maximum set value must be over minimum set value in case that the condition of too high as well as too low will happen.

⚠ NOTE: When setting the warning alarm, please set the correct return value; otherwise, maybe there is abnormal alarm. When setting the maximum value, the return value must less than set value; When setting the minimum value, the return value must over than set value.

⚠ NOTE: Digital input could not be set as same items; otherwise, there are abnormal functions. However, the digital output can be set as same items.

8 SENSOR SELECT

- 1) When reselect sensors, the sensor curve will be transferred into the standard value. For example, if temperature sensor is SGX (120°C resistor type), its sensor curve is SGX (120°C resistor type); if select the SGD (120°C resistor type), the temperature sensor curve is SGD curve.
- 2) When there is difference between standard sensor curves and using sensor, user can adjust it in “curve type”.
- 3) When input the sensor curve, X value (resistor) must be input from small to large, otherwise, mistake occurs.
- 4) If select sensor type as “None”, sensor curve is not working and LCD does not display the sensor information.
- 5) If there is alarm switch only for the select sensor, user must set the sensor as “None”, otherwise, maybe shutdown or warning occurs.
- 6) The headmost or backmost values in the vertical coordinates can be set as same as below,

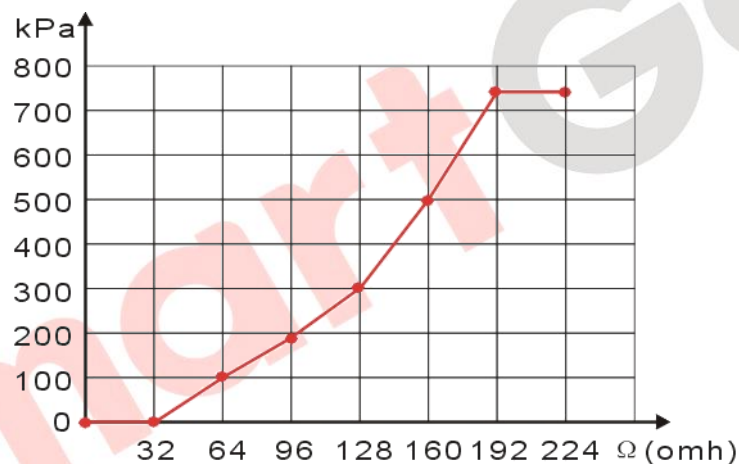

Common unit conversion table

	N/m² (pa)	kgf/cm²	bar	(p/in².psi)
1Pa	1	1.02x10 ⁻⁵	1x10 ⁻⁵	1.45x10 ⁻⁴
1kgf/cm ²	9.8x10 ⁴	1	0.98	14.2
1bar	1x10 ⁵	1.02	1	14.5
1psi	6.89x10 ³	7.03x10 ⁻²	6.89x10 ⁻²	1



9 TYPICAL APPLICATION

FPC915 TYPICAL APPLIATION

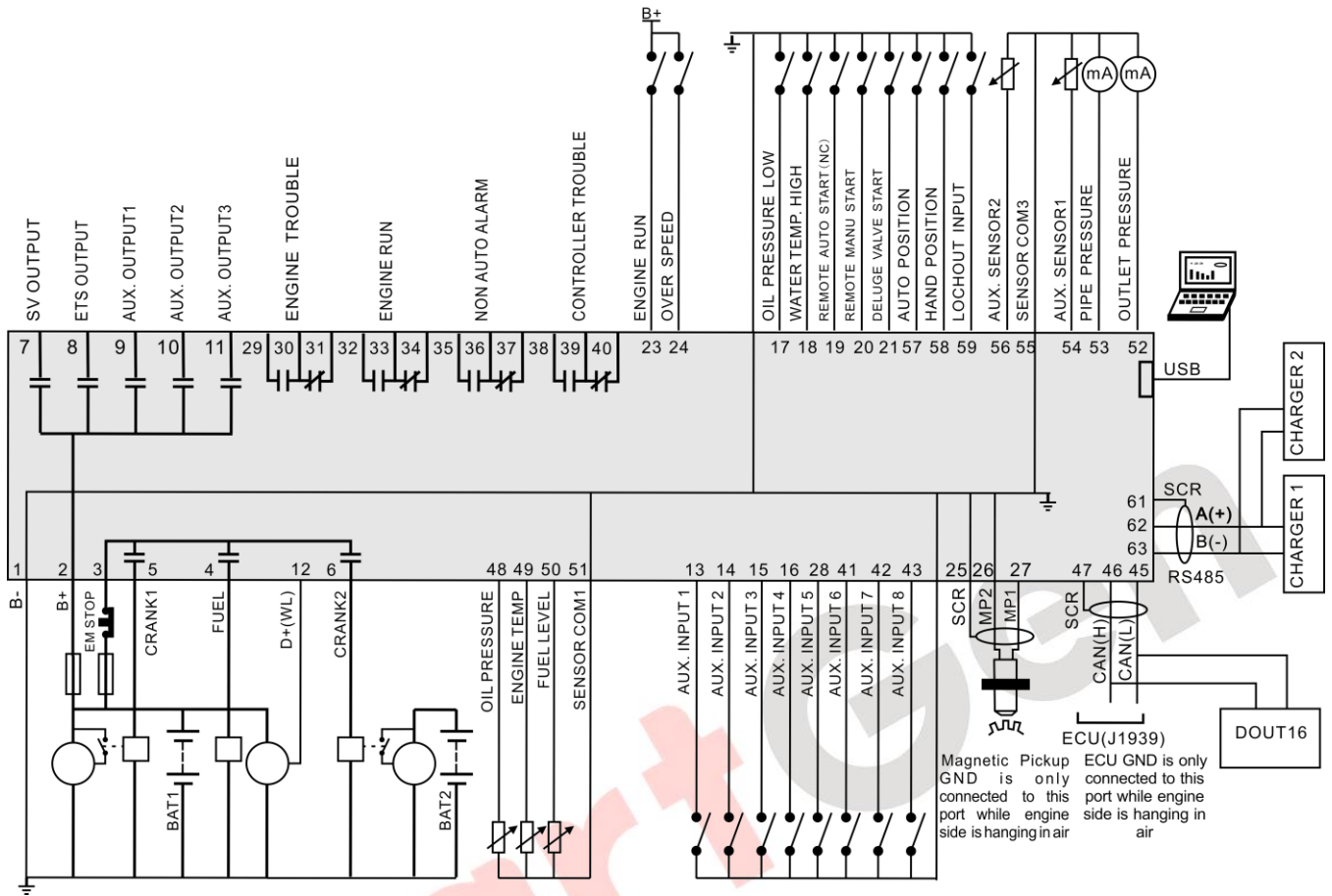

10 INSTALLATION

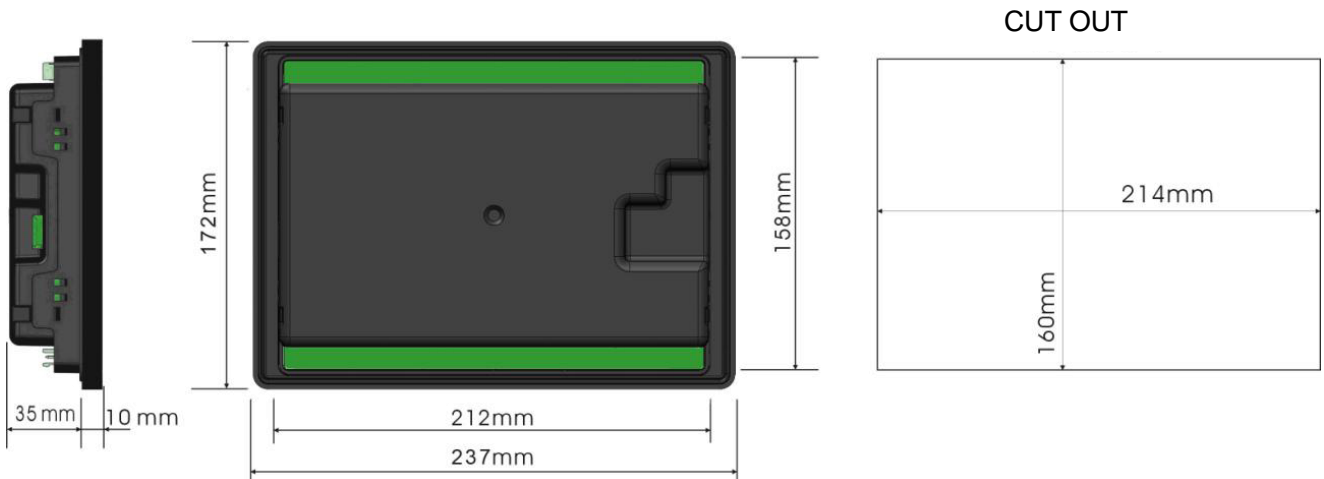

Controller is panel built-in design; it is fixed by clips when installed.

1) Battery Voltage Input

NOTE: FPC915 controller can suit for widely range of battery voltage DC(8~35)V. Negative of battery must be connected with the engine shell soundly. The diameter of wire which from power supply to battery must be over 2.5mm^2 . If floating charge configured, please firstly connect output wires of charger to battery's positive and negative directly, then, connect wires from battery's positive and negative to controller's corresponding input ports in order to prevent charge disturbing the controller's normal working.

2) Speed Sensor Input

NOTE: Speed sensor is the magnetic equipment which be installed in starter and for detecting flywheel teeth. Its connection wires to controller should apply for 2 cores shielding line. The shielding layer should connect to shielding GND terminal in controller while another side is hanging in air. The else two signal wires are connected to MP1 and MP2 terminals, moreover, MP2 has already connected to B- innerly. The output voltage of speed sensor should be within AC(1~24)V (effective value) during the full speed. AC12V is recommended (in rated speed). When install the speed sensor, let the sensor is spun to contacting flywheel first, then, port out 1/3 lap, and lock the nuts of sensor at last.

3) Output And Expansion Relay

NOTE: All outputs of controller are relay contact output type. If need to expand the relays, please add freewheel diode to both ends of expand relay's coils (when coils of relay has DC current) or, add resistance-capacitance return circuit (when coils of relay has AC current), in order to prevent disturbance to controller or others equipment.

11 CONNECTIONS OF CONTROLLER WITH J1939 ENGINE

11.1 CUMMINS ISB/ISBE

Terminals of controller	Connector B	Remark
Fuel relay output	39	
Start relay output	-	Connect with starter coil directly
Auxiliary output port 1	Expand 30A relay, battery voltage of 01,07,12,13 is supplied by relay	ECU power

Terminals of controller	Connector B	Remark
Fuel relay output	39	
Start relay output	-	Connect with starter coil directly
Auxiliary output port 1	Expand 30A relay, battery voltage of 01,07,12,13 is supplied by relay	ECU power

Engine type: Cummins ISB

11.2 CUMMINS QSL9

Suitable for CM850 engine control mode

Terminals of controller	50 pins connector	Remark
Fuel relay output	39	
Start relay output	-	Connect to starter coil directly

Terminals of controller	50 pins connector	Remark
Fuel relay output	39	
Start relay output	-	Connect to starter coil directly
Terminals of controller	9 pins connector	Remark

Engine type: Cummins-CM850

11.3 CUMMINS QSM11

It is suitable for CM570 engine control module. Engine type is QSM11 G1, QSM11 G2.

Terminals of controller	C1 connector	Remark
Fuel relay output	5&8	Outside expand relay, when fuel output, making port 5 and port 8 of C1 be connected
Start relay output	-	Connect to starter coil directly

Terminals of controller	C1 connector	Remark
Fuel relay output	5&8	Outside expand relay, when fuel output, making port 5 and port 8 of C1 be connected
Start relay output	-	Connect to starter coil directly
Terminals of controller	3 pins data link connector	Remark

Engine type: Cummins ISB

11.4 CUMMINS QSX15-CM570

It is suitable for CM570 engine control module. Engine type is QSX15.

Terminals of controller	50 pins connector	Remark
Fuel relay output	38	Oil spout switch
Start relay output	-	Connect to starter coil directly

Terminals of controller	50 pins connector	Remark
Fuel relay output	38	Oil spout switch
Start relay output	-	Connect to starter coil directly
Terminals of controller	9 pins connector	Remark

Engine type: Cummins QSX15-CM570

11.5 CUMMINS GCS-MODBUS

It is suitable for GCS engine control module. Use RS485-MODBUS to read information of engine. Engine types are QSX15, QST30, QSK23 / 45/60/78 and so on.

Terminals of controller	D-SUB connector 06	Remark
Fuel relay output	5&8	Outside expand relay, when fuel output, making port 05 and 08 of the connector 06 be connected.
Start relay output	-	Connect to starter coil directly

Terminals of controller	D-SUB connector 06	Remark
Fuel relay output	5&8	Outside expand relay, when fuel output, making port 05 and 08 of the connector 06 be connected.
Start relay output	-	Connect to starter coil directly
Terminals of controller	D-SUB connector 06	Remark

Engine type: Cummins QSK-MODBUS, Cummins QST-MODBUS, Cummins QSX-MODBUS

11.6 CUMMINS QSM11

Terminals of controller	OEM connector of engine	Remark
Fuel relay output	38	
Start relay output	-	Connect with starter coil directly
CAN GND	-	CAN communication shielding line(connect with controller's this terminal only)
CAN(H)	46	Impedance 120Ω connecting line is recommended.
CAN(L)	37	Impedance 120Ω connecting line is recommended.

Engine type: common J1939

11.7 CUMMINS QSZ13

Terminals of controller	OEM connector of engine	Remark
Fuel relay output	45	
Start relay output	-	Connect to starter coil directly
Programmable output 1	16&41	Setting to idle speed control, normally open output. Making 16 connect to 41 during high-speed running of controller via external expansion relay.
Programmable output 2	19&41	Setting to pulse raise speed control, normally open output. Making 19 connect with 41 for 0.1s during high-speed warming of controller via external expansion relay.
CAN GND	-	CAN communication shielding line(connect with controller's this terminal only)
CAN(H)	1	Impedance 120Ω connecting line is recommended.
CAN(L)	21	Impedance 120Ω connecting line is recommended.

Engine type: QSZ13, speed regulation can be implemented.

11.8 DETROIT DIESEL DDEC III / IV

Terminals of controller	CAN port of engine	Remark
Fuel relay output	Expand 30A relay, battery voltage of ECU is supplied by relay	
Start relay output	-	Connect to starter coil directly
CAN GND	-	CAN communication shielding line (connect with controller's terminal only)
CAN(H)	CAN(H)	Impedance 120Ω connecting line is recommended.
CAN(L)	CAN(L)	Impedance 120Ω connecting line is recommended.

Engine type: Common J1939

11.9 DEUTZ EMR2

Terminals of controller	F connector	Remark
Fuel relay output	Expand 30A relay, battery voltage of 14 is supplied by relay. Fuse is 16A.	
Start relay output	-	Connect to starter coil directly
-	1	Connect to battery negative pole
CAN GND	-	CAN communication shielding line(connect with controller's terminal only)
CAN(H)	12	Impedance 120Ω connecting line is recommended.
CAN(L)	13	Impedance 120Ω connecting line is recommended.

Engine type: VolvoEDC4

11.10 JOHN DEERE

Terminals of controller	21 pins connector	Remark
Fuel relay output	G,J	
Start relay output	D	
CAN GND	-	CAN communication shielding line(connect with controller's terminal only)
CAN(H)	V	Impedance 120Ω connecting line is recommended.
CAN(L)	U	Impedance 120Ω connecting line is recommended.

Engine type: John Deere

11.11 MTU MDEC

Suitable for MTU engines, 2000 series, 4000series

Terminals of controller	X1 connector	Remark
Fuel relay output	BE1	
Start relay output	BE9	
CAN GND	E	CAN communication shielding line(connect with one terminal only)
CAN(H)	G	Impedance 120Ω connecting line is recommended.
CAN(L)	F	Impedance 120Ω connecting line is recommended.

Engine type: MTU-MDEC-303

11.12 MTU ADEC(SMART MODULE)

It is suitable for MTU engine with ADEC (ECU8) and SMART module.

Terminals of controller	ADEC (X1port)	Remark
Fuel relay output	X1 10	X1 Terminal 9 Connected to negative of battery
Start relay output	X1 34	X1 Terminal 33 Connected to negative of battery

Terminals of controller	SMART (X4 port)	Remark
CAN GND	X4 3	CAN communication shielding line(connect to controller's this terminal only)
CAN(H)	X4 1	Impedance 120Ω connecting line is recommended.
CAN(L)	X4 2	Impedance 120Ω connecting line is recommended.

Engine type: MTU-ADEC

11.13 MTU ADEC(SAM MODULE)

It is suitable for MTU engine with ADEC (ECU7) and SAM module.

Terminals of controller	ADEC (X1port)	Remark
Fuel relay output	X1 43	X1 Terminal 28 Connected to negative of battery
Start relay output	X1 37	X1 Terminal 22 Connected to negative of battery

Terminals of controller	ADEC (X1port)	Remark
Fuel relay output	X1 43	X1 Terminal 28 Connected to negative of battery
Start relay output	X1 37	X1 Terminal 22 Connected to negative of battery
Terminals of controller	SAM (X23 port)	Remark

Engine type: Common J1939

11.14 PERKINS

It is suitable for ADEM3/ ADEM4 engine control module. Engine type is 2306, 2506, 1106, and 2806.

Terminals of controller	Connector	Remark
Fuel relay output	1, 10, 15, 33, 34	
Start relay output	-	Connect to starter coil directly
CAN GND	-	CAN communication shielding line(connect with controller's terminal only)
CAN(H)	31	Impedance 120Ω connecting line is recommended.
CAN(L)	32	Impedance 120Ω connecting line is recommended.

Engine type: Perkins

11.15 SCANIA

It is suitable for S6 engine control module. Engine type is DC9, DC12, and DC16.

Terminals of controller	B1 connector	Remark
Fuel relay output	3	
Start relay output	-	Connect to starter coil directly
CAN GND	-	CAN communication shielding line(connect with controller's terminal only)
CAN(H)	9	Impedance 120Ω connecting line is recommended.
CAN(L)	10	Impedance 120Ω connecting line is recommended.

Engine type: Scania

11.16 VOLVO EDC3

Suitable engine control mode is TAD1240, TAD1241, and TAD1242.

Terminals of controller	"Stand alone" connector	Remark
Fuel relay output	H	
Start relay output	E	
Programmable output 1	P	ECU power supply

Terminals of controller	"Stand alone" connector	Remark
Fuel relay output	H	
Start relay output	E	
Programmable output 1	P	ECU power supply

Engine type: Volvo

▲ NOTE: When this type is selected, preheating time should be set to at least 3 seconds.

11.17 VOLVO EDC4

Suitable engine types are TD520, TAD520 (optional), TD720, TAD720 (optional), TAD721, TAD722, and TAD732.

Terminals of controller	Connector	Remark
Fuel relay output	Expanded 30A relay, and relay offers battery voltage for terminal14. Fuse is 16A	
Start relay output	-	Connect to starter coil directly
	1	Connected to negative of battery
CAN GND	-	CAN communication shielding line(connect with controller's terminal only)
CAN(H)	12	Impedance 120Ω connecting line is recommended.
CAN(L)	13	Impedance 120Ω connecting line is recommended.

Engine type: VolvoEDC4

11.18 VOLVO-EMS2

Volvo Engine types are TAD734, TAD940, TAD941, TAD1640, TAD1641, and TAD1642.

Terminals of controller	Engine's CAN port	Remark
Programmable output 1	6	ECU stop Set programmable output 1 as "ECU stop"
Programmable output 2	5	ECU power Set programmable output 2 as "ECU power"
	3	Negative power
	4	Positive power
CAN GND	-	CAN communication shielding line(connect with controller's terminal only)
CAN(H)	1(Hi)	Impedance 120Ω connecting line is recommended.
CAN(L)	2(Lo)	Impedance 120Ω connecting line is recommended.

Engine type: Volvo-EMS2, speed regulation can be implemented.

▲ NOTE: When this type is selected, preheating time should be set to at least 3 seconds.

11.19 YUCHAI

It is suitable for BOSCH common rail pump engine.

Terminals of controller	Engine 42 pins port	Remark
Fuel relay output	1.40	Connect to engine ignition lock
Start relay output	-	Connect to starter coil directly
CAN GND	-	CAN communication shielding line(connect with controller's this terminal only)
CAN(H)	1.35	Impedance 120Ω connecting line is recommended.
CAN(L)	1.34	Impedance 120Ω connecting line is recommended.

Terminals of controller	Engine 42 pins port	Remark
Fuel relay output	1.40	Connect to engine ignition lock
Start relay output	-	Connect to starter coil directly

Engine type: BOSCH, speed regulation can be implemented.

11.20 WEICHAI

It is suitable for Weichai BOSCH common rail pump engine.

Terminals of controller	Engine port	Remark
Fuel relay output	1.40	Connect to engine ignition lock
Start relay output	1.61	
CAN GND	-	CAN communication shielding line(connect to the controller at this end only)
CAN(H)	1.35	Impedance 120Ω connecting line is recommended.
CAN(L)	1.34	Impedance 120Ω connecting line is recommended.

Engine type: GTSC1, speed regulation can be implemented.

▲ NOTE: If there is any question about connection between controller and ECU communication, please feel free to contact Smartgen's service.

12 USB

Users can set the controller's parameters and monitor the controller's status via USB port using the test software which provided by Smartgen company. USB port is active in stop mode only while at other times it couldn't be detected by PC.

13 FAULT FINDING

Symptoms	Possible Solutions
Controller no response with power.	Check starting batteries; Check controller connection wirings; Check DC fuse.
Genset shutdown	Check the water/cylinder temperature is too high or not; Check DC fuse.
Controller emergency stop	Check emergence stop button is correct or not; Check whether the positive of starting battery is connected with the emergency stop input; Check whether the circuit is open.
Low oil pressure alarm after crank disconnect	Check the oil pressure sensor and its connections.
High water temp. alarm after crank disconnect	Check the temperature sensor and its connections.
Shutdown Alarm in running	Check related switch and its connections according to the information on LCD; Check programmable inputs.
Crank not disconnect	Check fuel oil circuit and its connections; Check starting batteries; Check speed sensor and its connections; Refer to engine manual.
Starter no response	Check starter connections; Check starting batteries.
RS485 COM Fail	Check connections; Check setting of COM port is correct or not; Check RS485's connections of A and B is reverse connect or not; Check RS485 transfer model whether damage or not; Check communication port of PC whether damage.
ECU COM Fail	Check connections of CAN high and low polarity; Check if correctly connected of 120Ω resistor; Check if engine type is correct; Check if connections from controller to engine and outputs setting are correct.
ECU Warning or Shutdown	Get information from LCD of alarm page; If there is detailed alarm, check engine according to description. If not, please refer to engine manual according to SPN alarm code.