

DC5xD MK3 GENSET CONTROLLER USER MANUAL

DC50D MK3



DC52D MK3



Software Version

No.	Version	Date	Note
1	V1.0	2020-08-01	Original release.
2	V1.1	2021-02-04	Unify the description of input and output ports.



Chongqing Mebay Technology Co.,Ltd

Add: No6-2,Building 4, Gangan Rd, Jiangbei District, Chongqing.

Tel: +86-23-6869 3061



Fax: +86-23-6765 8207

Web: <http://www.mebay.cn>

<http://www.cqmb.cn>

E_mail: sales@mebay.cn

Symbol Description

Symbol	Description
 Note	Remind operators to operate correctly, otherwise it may cause the equipment not to work correctly.
 Be care	It is indicated that potential hazards can damage equipment without proper precautions.
 Warning	It is indicated if appropriate preventive measures are not taken, potentially dangerous situations may result in death, serious personal injury or significant property losses.

Warning

1. The installation of this equipment must be carried out by professionals.
2. When installing and operating the controller, please read the entire instruction manual first.
3. Any maintenance and commissioning of the equipment must be familiar with all the equipment.
4. t, safety standards and precautions in advance, otherwise it may cause personal injury or damage to related equipment.
5. The engine must have an overspeed protection device independent of the controller system to avoid casualties or other damage caused by engine out of control.
6. After the installation of the controller is completed, please verify that all protection functions are valid.

Be Care

1. Please keep the good connection of the power supply of the controller. Do not share the connection lines of the positive and negative electrodes of the battery with the floating charger.
2. During the operation of the engine, do not disconnect the battery, otherwise it may cause damage to the controller.

CATALOGUE

1. Summary.....	5
2. Main Features.....	5
3. Parameters Display.....	6
4. Protection.....	6
5. Parameters.....	7
6. Overall Dimension and Wiring Diagram.....	8
7. Installation instruction.....	15
8. Panel and display.....	16
9. Control and operation instruction.....	19
10. Warnings and Shutdown Alarms.....	21
11. Parameters setting.....	28
12. Fault finding.....	41

Notes:

1. All rights reserved. No part of this duplication may be reproduced in any material form (including photocopying or storing in any medium by electronic means or others) without the written permission of the copyright holder.
2. MEBAY Technology reserves the rights to change the contents of this document without prior notice.

1. Summary

This series controller is specialized for Diesel / Gasoline / Gas Genset Start, Stop, Parameters monitoring, faults-checking as well as data setting.

3.5 inch LCD screen display with brand new UI design is adapted in this controller that the relative failures can be displayed directly. All the parameters can be displayed by simulated indicators and words. Besides, LCD screen can display various faults in the same time that the genset will be stopped once it can't work smoothly.

There are Chinese/English interface options, more language can be set according to user's request. All the parameters can be configured through the front face buttons or use programmable interface by RS485 or USB to adjust via PC. It can be widely applied for all kinds of auto control system of gensets.

2. Main Features

There are four Models under DC5xD MK3 series.

DC50D MK3: used for single machine automation. Start/Stop through remote start signal.

DC52D MK3: Based on DC50D MK3, it adds Mains monitoring and AMF (Mains/Generator automatic switching control), especially suitable for the automation system composed by mains and genset.

DC50DR MK3: Based on DC50D MK3, it adds RS485 port.

DC52DR MK3: Based on DC52D MK3, it adds RS485 port.

- ◆ Dual core 32bit high performance single chip microcomputer.
- ◆ 3.5 inch 240 * 128 high-resolution LCD screen, Available in 6 languages, user's language set if necessary.
- ◆ Indicator and number display through UI surface.
- ◆ Acrylic material is adapted to protect the screen.
- ◆ Silicone panels;
- ◆ USB Port: parameters can be set even without power through USD port to monitor in real time.
- ◆ With RS485 communication port, can achieve "Three Remote" functions via MODBUS protocol.
- ◆ Various kinds of parameters display.
- ◆ Input/output function, status can be shown directly.
- ◆ Real time clock inside: preset time operate and auto maintenance is available. Genset working plan can be set as per week or month.
- ◆ Maintenance countdown function, can set maintenance time or date.
- ◆ The black box function can save the relevant parameters of the unit when the fault alarm occurs in real time, and it is convenient to find the cause of the fault.
- ◆ Totally 6relay's output, among which 4 relay output can be self-configurable, each relay can be set as max 20 functions, besides, there are 3 groups as non-contact terminals.
- ◆ With 5 switches input, up to 20 functions optional;
- ◆ 3 sensor simulation input connectors, the oil pressure sensor is compatible with voltage signal input, and various display units can be configured.

- ◆ Battery charging control function, which can protect the battery according to battery voltage status.
- ◆ Sensor can be self-defined by front face button or PC software.
- ◆ Adapt to 3P4W, 1P2W, 2P3W (120V/240V, 50/60HZ)
- ◆ Various of crank conditions (RPM, Frequency, Oil Pressure) can be chosen.
- ◆ Control Protection: Auto Start/Stop of genset, load transfer (ATS control) and perfect failure display and protection.
- ◆ Standard water-proof rubber gasket. The waterproof can reach IP54
- ◆ Module design: All the connections are adapted with European connectors so that installation, connection, repair and replacement can be more easily.

3. Parameters Display

- ◆ Engine RPM
- ◆ Engine oil pressure
- ◆ Engine temperature
- ◆ Engine fuel level
- ◆ Engine battery voltage
- ◆ Charging voltage
- ◆ Mains Frequency (only for DC52D MK3)
- ◆ Mains phase voltage L-N (only for DC52D MK3)
- ◆ Mains phase voltage L-L (only for DC52D MK3)
- ◆ Generator 3 Phase voltage L-N
- ◆ Generator 3 Phase voltage L-L
- ◆ Generator 3 phase current A
- ◆ Generator Frequency Hz
- ◆ Generator Power Factor COS φ
- ◆ Generator active power KW
- ◆ Generator apparent power KVA
- ◆ Generator reactive power KVar
- ◆ Real-time load rate %
- ◆ Current load rate %
- ◆ Average loading rate %
- ◆ Current consumption KWH
- ◆ Total consumption KWH
- ◆ Total Crank times
- ◆ Cumulative power on time of controller
- ◆ Current running time
- ◆ Total running time
- ◆ Maintenance notice
- ◆ Switches input status display
- ◆ Output status display of relays
- ◆ Current date and time;

4. Protection

- ◆ Over speed
- ◆ Under speed

- ◆ Low oil pressure
- ◆ High temperature
- ◆ Low fuel level
- ◆ External emergency alarm
- ◆ D+ open
- ◆ RPM Lost
- ◆ Sensor Open
- ◆ Over Frequency
- ◆ Under Frequency
- ◆ Over voltage
- ◆ Under voltage
- ◆ Over current
- ◆ Non-balance of current
- ◆ Over power
- ◆ Maintenance expire
- ◆ Low water level alarm
- ◆ Emergency Stop
- ◆ Crank failure
- ◆ Battery over voltage
- ◆ Battery under voltage
- ◆ The charger fails to charge
- ◆ Charger charging failure
- ◆ Stop Failure

5. Parameters

Options	Parameters
Working voltage	DC8V----36V Continuous
Power consumption	Standby: 24V: MAX 1W
	Working: 24V: MAX5W
AC Voltage Input	1P2W 30VAC-276VAC (ph-N)
	2P3W 30VAC-276VAC (ph-N)
	3P4W 30VAC-276VAC (ph-N)
Rotate speed sensor Frequency	50-10000Hz
MAX Accumulating Time	99999.9Hours (Min Store time:6min)
Fuel Relay Output	Max 16Amp DC+VE Supply voltage
Start Relay Output	Max 16Amp DC+VE Supply voltage
AUX. OUTPUT 1	Max 16Amp DC+VE Supply voltage
AUX. OUTPUT 2	Max 16Amp DC+VE Supply voltage

AUX. OUTPUT 3	5AMP Non-contact normal open output
AUX. OUTPUT 4	5AMP Non-contact normal open output
Excitation output	Max 1AMP DC+VE supply voltage
Switch value input	Available if connecting with Battery -
Working condition	-25-65°C
Storage condition	-40-85°C
Protection Level	IP54: when waterproof rubber gasket is added between controller and its panel
Insulation strength	Apply AC1.5kV voltage between high voltage terminal and low voltage terminal; The leakage current is not more than 3mA within 1min.
Overall dimension	210mm*160mm*50mm
Panel cutout	186mm*142mm
Weight	0.85Kg

6. Overall Dimension and Wiring Diagram

◆ Overall Dimension:



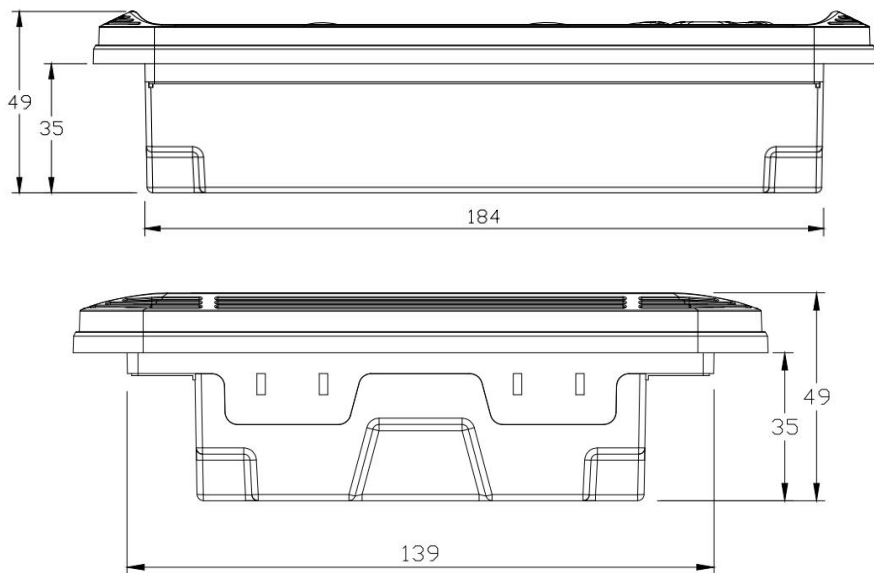

◆ Descriptions of terminal connection

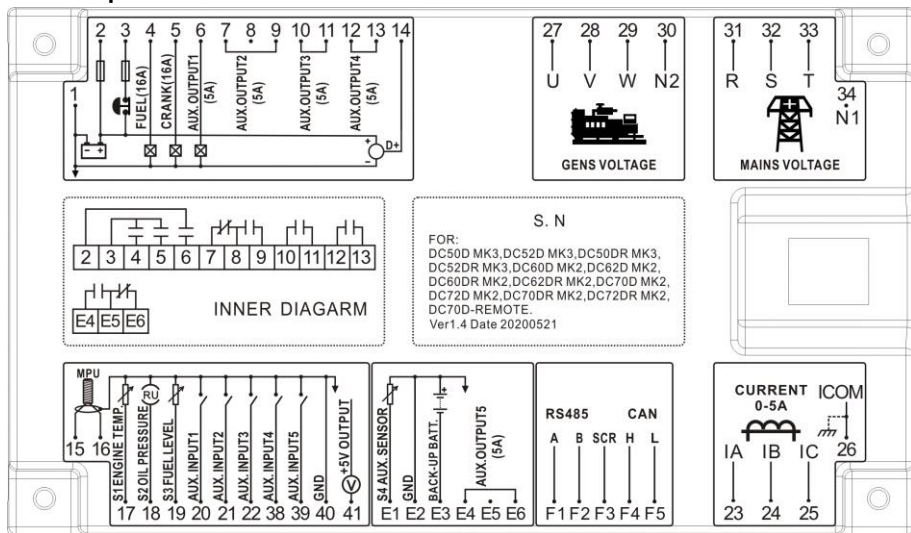

No.	Function	Description	Cable cross sectional area
1	Battery Negative Input B-	Controller power supply input B-.	2.5mm ²
2	Battery Negative Input B+	Controller power supply input B+.	2.5mm ²
3	Emergency Stop Input	B+ voltage input is active, and connected to	2.5mm ²

		emergency stop normal closed button.	
4	Fuel Output	+VE output, Max 16Amp	1.5mm ²
5	Crank Output	+VE output, Max 16Amp.	1.5mm ²
6	Aux. Ouput 1	+VE output, Max 5Amp.	1.5mm ²
7	Aux. Ouput 2 Normal close	Passive Output, Max 5Amp.	1.5mm ²
8	Aux. Ouput 2 Common		1.5mm ²
9	Aux. Ouput 2 Normal open		1.5mm ²
10	Aux.Output 3	Passive normally open output, Max 5Amp.	1.5mm ²
11	Aux.Output 3		1.5mm ²
12	Aux.Output 4	Passive normally open output, Max 5Amp.	1.5mm ²
13	Aux.Output 4		1.5mm ²
14	Charging excitation output	+VE output, Max 0.9Amp.	1.0mm ²
15	Speed sensor -	Use a shielded wire to connect the speed sensor.	1.0mm ²
16	Speed sensor +		1.0mm ²
17	Temperature Sensor	Connect sensor input.	1.0mm ²
18	Oil pressure sensor		1.0mm ²
19	Fuel level sensor		1.0mm ²
20	Aux. Input 1	The grounding is valid according to the function selection switch input.	1.0mm ²
21	Aux. Input 2		1.0mm ²
22	Aux. Input 3		1.0mm ²
23	Load CT Secondary L1	Current Transformer Secondary Rated 5A.	1.5mm ²
24	Load CT Secondary L2		1.5mm ²
25	Load CT Secondary L3		1.5mm ²
26	Load CT Secondary ICOM	Connect to the common.	1.5mm ²
27	Generator Voltage U	Connected to the power generation output R phase.	1.0mm ²
28	Generator Voltage V	Connected to the power generation output S phase.	1.0mm ²
29	Generator Voltage W	Connected to the power generation output T phase.	1.0mm ²
30	Generator Voltage N2	Connected to the power generation output N phase.	1.0mm ²
31	Mains Voltage R	Connected to the mains U phase.	1.0mm ²
32	Mains Voltage S	Connected to the mains V phase.	1.0mm ²
33	Mains Voltage T	Connected to the mains W phase.	1.0mm ²
34	Mains Voltage N1	Connected to the mains N phase.	1.0mm ²
38	Aux. Input 4	The grounding is valid according to the function selection switch input.	1.0mm ²
39	Aux. Input 5		1.0mm ²
40	Sensor common GND	Connect the battery negative or outer.	1.0mm ²

41	+5V Output	Connect the power supply of the oil pressure sensor with the output voltage signal, with a maximum of 50mA.	1.0mm ²
F1	RS485 B	A 120 Ω shielded wire and good grounding are recommended.	1.0mm ²
F2	RS485 A		1.0mm ²
F3	RS485 SCR		1.0mm ²

◆ **DC50D MK3 3-phase 4-wire Typical Wiring Diagram**

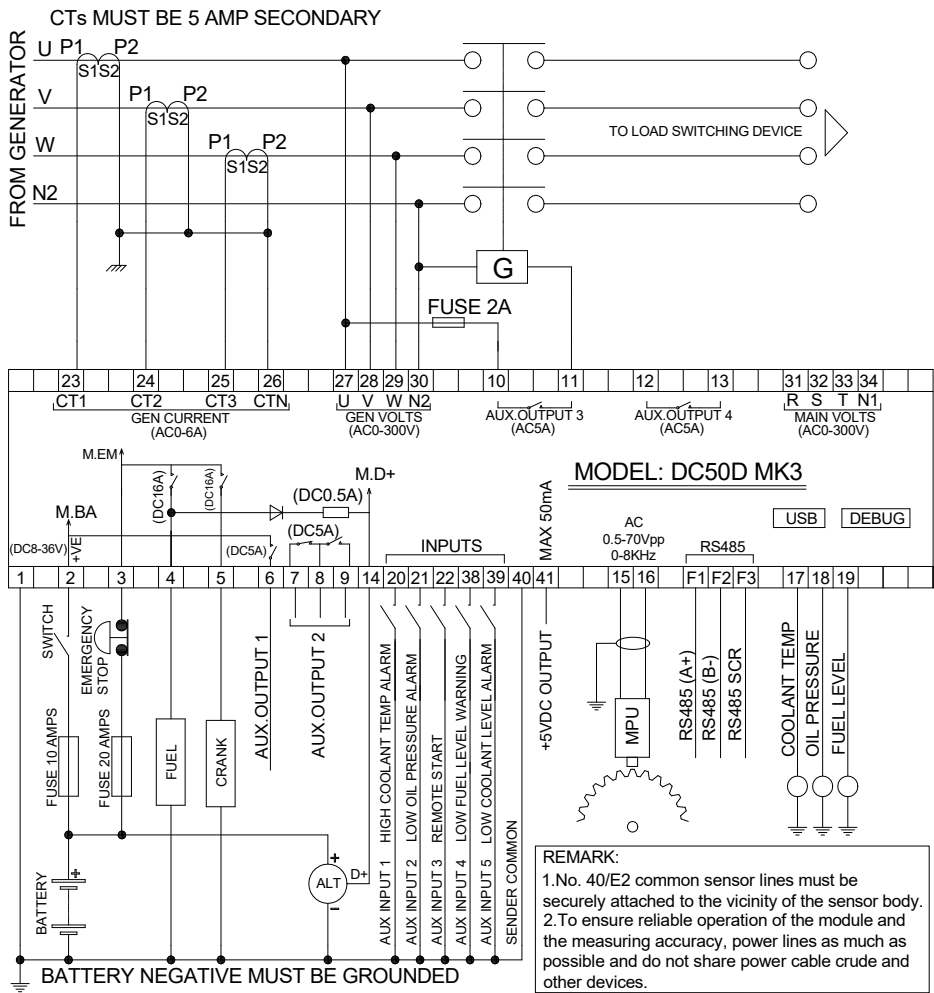

⚠ Note: Please don't move battery during running status or it may cause the controller broken!

⚠ WARNING: When generator is on-load, C. T. secondary must not be open circuit, Otherwise, the high voltage generated will pose a danger to personal safety.

◆ **DC52D MK3 3-phase 4-wire Typical Wiring Diagram**

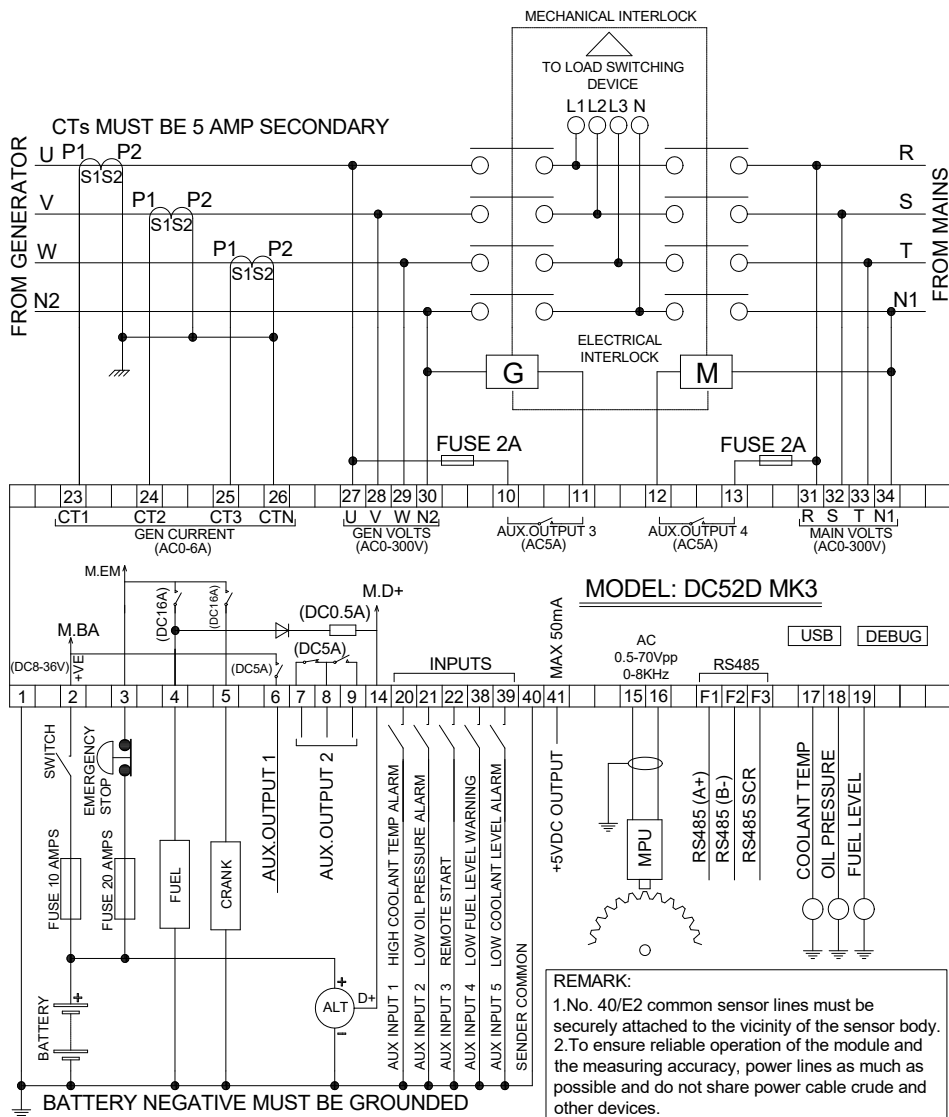

Note: Please don't move during running status or it may cause the controller broken!



WARNING: When generator is on-load, C. T. secondary must not be open circuit, Otherwise, the high voltage generated will pose a danger to personal safety.

◆ **DC50D MK3 1-phase 2-wire Typical Wiring Diagram**

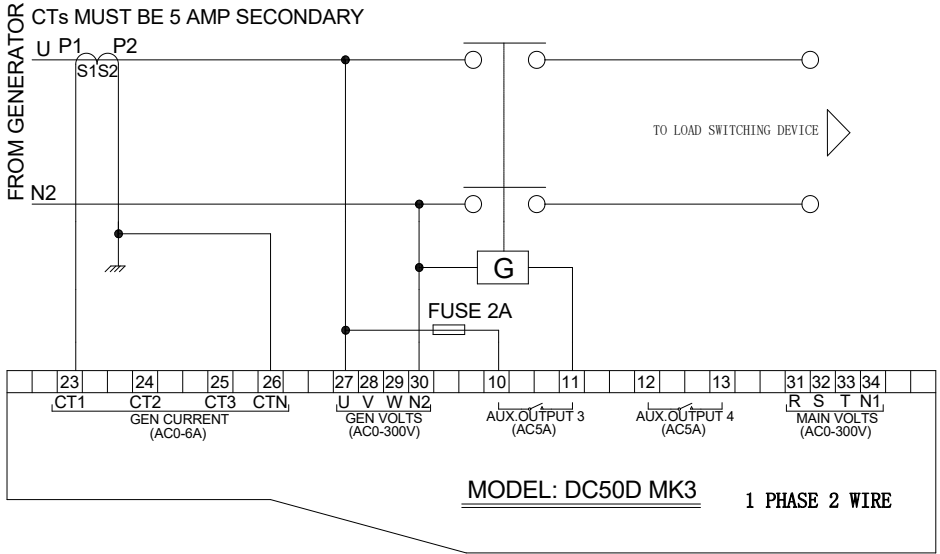

◆ **DC50D MK3 2-phase 3-wire Typical Wiring Diagram**

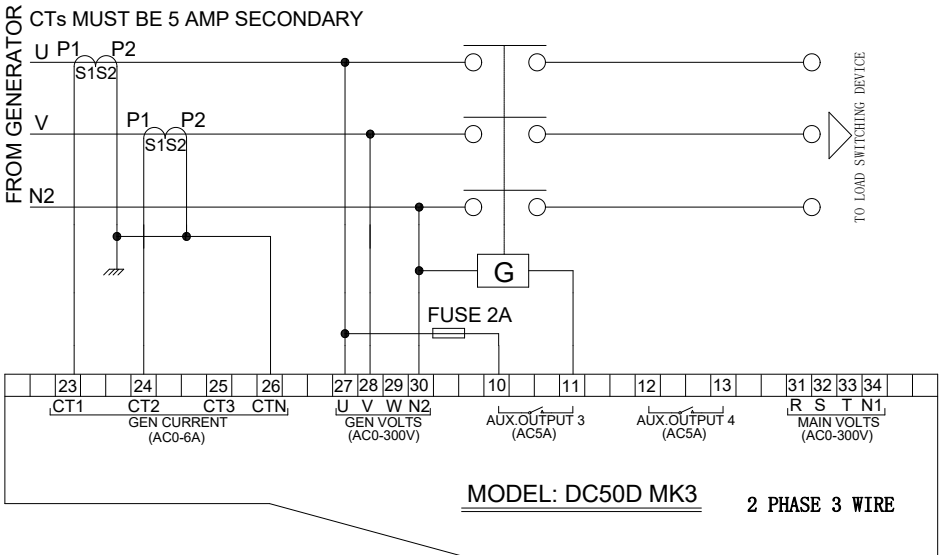

◆ **DC52D MK3 1-phase 2-wire Typical Wiring Diagram**

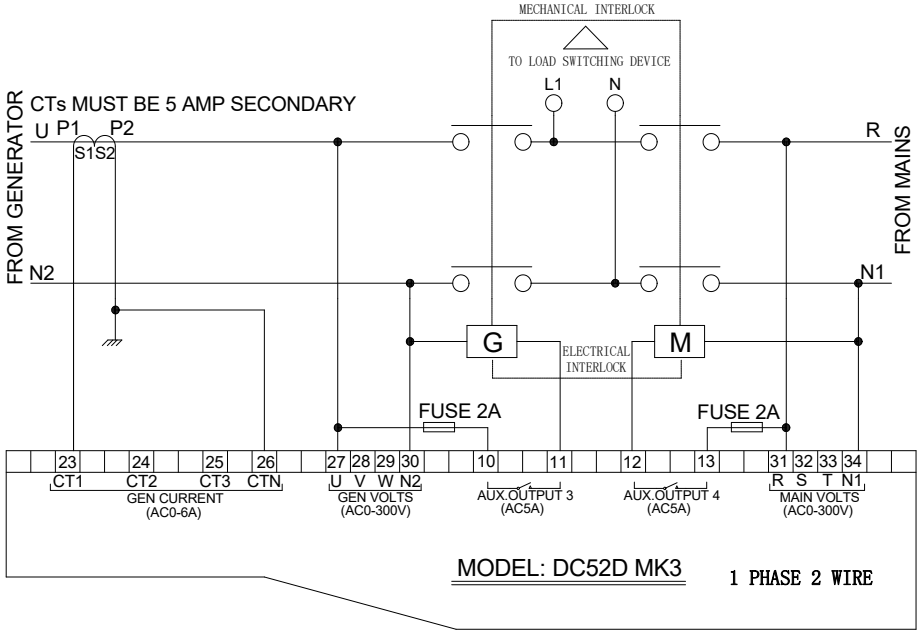

DC50D MK3 2-phase 3-wire Typical Wiring Diagram

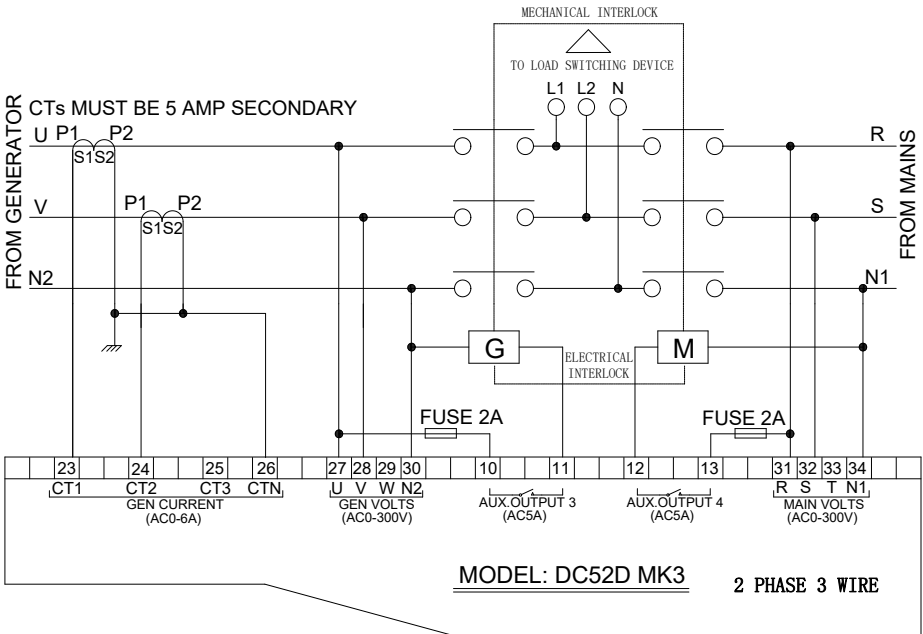

7. Installation instruction

- ◆ The controller is fixed by four special fixing members and screws, and the screws of the metal fasteners cannot be too tight.
- ◆ Panel Cutout: W220mm*H160mm.

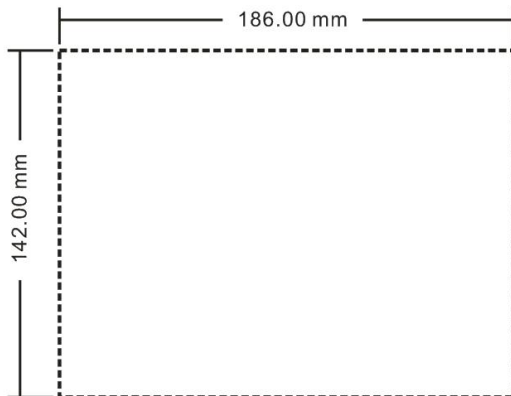

Note: If the controller is installed directly in the genset shell or other fluctuated equipment, the rubber pad must be installed.

◆ Battery Voltage Input

DC5xD MK3 controller is suitable for 8-36V DC battery voltage. Battery negative must be reliably connected to the enclosure of the engine. The controller power supply B+ and B- must be connected to battery positive and negative, and the wire size must not be less than 2.5mm².



NOTE:

In case of floating charger connect charger output to battery positive and negative directly, then, connect battery positive and negative poles to controller positive and negative power supply.

◆ Output and relay expansion



Note: All outputs of the controller are relay contacts. The maximum current capacity is described in the "Parameters" in this manual. Please use it in the relay current capacity. If an extended relay is needed, add a continuous current diode (when the extended relay coil is DC) or a resistance-capacitance loop (when the extended relay coil is AC) to both ends of the coil to prevent interference with the controller or other equipment.

◆ AC current input

Current transformer with rated secondary current 5A must be externally connected to the controller current input.



WARNING: When generator is on-load, C. T. secondary must not be open circuit, Otherwise, the high voltage generated will pose a danger to personal safety.

◆ **Withstanding voltage test**



If withstanding voltage test is conducted after the controller has already been installed onto the control panel, please unplug all controller terminal connections in order to prevent high voltage from damaging it.

8. Panel and display

◆ **DC50D MK3**

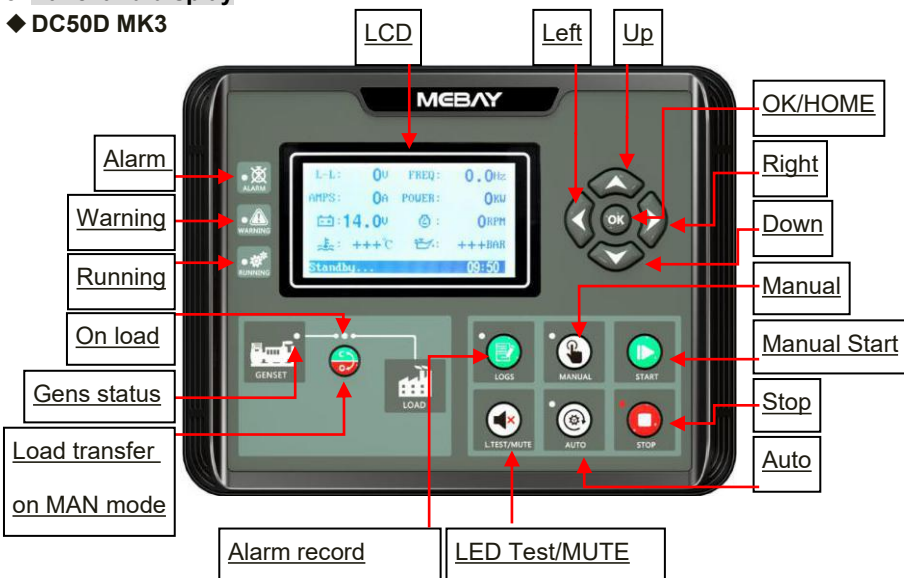

◆ **DC52D MK3**

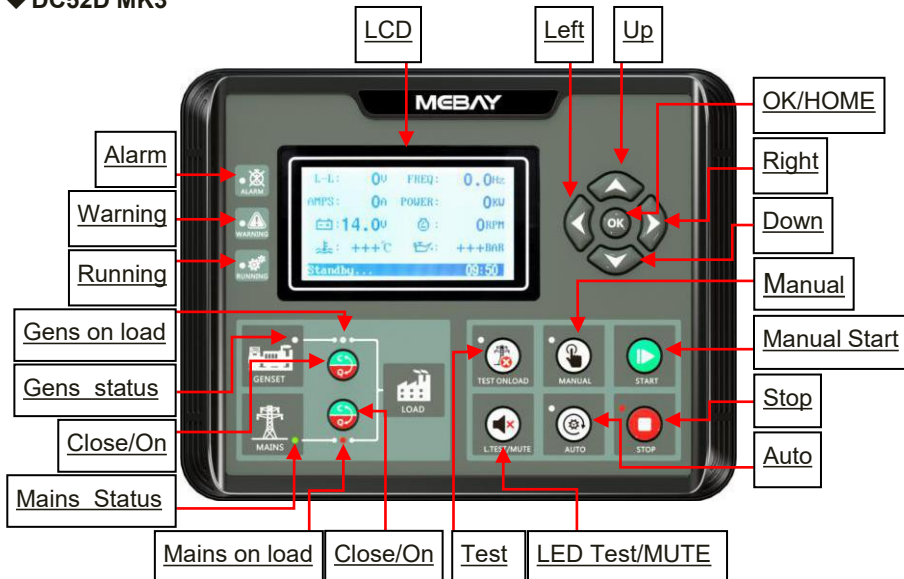

◆ Key Function Description

KEYS	NAME	Main Function
	Stop Reset Revert	<ul style="list-style-type: none"> ◆ Can stop generator under manual/auto mode; ◆ Can reset shutdown alarm ◆ During stop procession, pressing this key again can stop generator immediately. ◆ Pressing this key can cancel the setting and back to upper class under edition. ◆ Under the setting mode with checking data, the data can be saved and system will exit after pressing.
	Start	<ul style="list-style-type: none"> ◆ Start the genset under manual mode. ◆ Pressing this key can start the genset under manual testing mode.
	Manual	<ul style="list-style-type: none"> ◆ Pressing this key will set the module into manual mode.
	Auto	<ul style="list-style-type: none"> ◆ Pressing this key will set the module into auto mode.
	DC50D MK3 Records	<ul style="list-style-type: none"> ◆ Pressing this key to check the alarm records under stop mode.
	DC52D MK3 Test	<ul style="list-style-type: none"> ◆ Pressing this key to come into manual testing mode. ◆ Under testing mode, pressing MANUAL can start the genset and transfer to normal loading after running which is to test if the auto start is in normal status.
	LED Test/ Warning clear	<ul style="list-style-type: none"> ◆ Test if all LED lights are ok, pressing this key to test if all lighted, all off when loosen it. ◆ Under warning, pressing this key can clear warning and controller will re-check warning. ◆ Under alarm, pressing this key can clear the buzzer call. ◆ Pressing this key in 3 seconds can clear the buzzer call, pressing it again in 3 seconds can recover the buzzer call.
	Gens/ Mains Close/On	<ul style="list-style-type: none"> ◆ Under manual mode, pressing this key can transfer load to genset/mains.
	Left	<ul style="list-style-type: none"> ◆ Under display mode, pressing this key to turn left page. ◆ Under edition mode, pressing this key to move the digit.
	Right	<ul style="list-style-type: none"> ◆ Under display mode, pressing this key to turn right page. ◆ Under edition mode, pressing this key to move the digit.
	Up	<ul style="list-style-type: none"> ◆ Under display mode, parts of the page can move up. ◆ Under edition mode, pressing this key to move the digit or increase the numbers. ◆ Under records mode, pressing this key to move the digit.

	Down	<ul style="list-style-type: none"> ◆ Under display mode, parts of the page can move down. ◆ Under edition mode, pressing this key to move the digit or decrease the numbers. ◆ Under records mode, pressing this key to move the digit.
	OK UI Change	<ul style="list-style-type: none"> ◆ Confirm the change under edition mode. ◆ Page exited under records checking mode. ◆ Black UI and white UI can be switched when Pressing. ◆ In standby state, press for 3 seconds to enter the parameter setting mode.
+ 	Setting mode	<ul style="list-style-type: none"> ◆ Pressing OK and STOP simultaneously to come into setting mode
+	DC52D MK3 Alarm Records checking	<ul style="list-style-type: none"> ◆ Pressing STOP and RIGHT to check the records and any buttons pressed to exit from the page.

◆ Engine flywheel teeth automatic adjustment

1) Crank disconnect must be set to include both "speed" and "frequency" options.

2) When the generator frequency and engine speed are not zero, press

and for more than 0.5 seconds, the controller will automatically calculate and save the number of flywheel teeth according to the generation frequency and generator poles.

3) After calculating and saving the number of flywheel teeth successfully, the controller shows: "**Flywheel xxx teeth, saved successfully!**"

◆ Alarm records checking

DC5XD MK3 controller can save 14 groups of alarm records which contains time, gens parameter, engine parameter and so on. How to check the alarm records:

1) Enter alarm record page:

a) DC50D MK3: under stop mode, press to come into alarm records page;

b) DC52D MK3: press and simultaneously to come into alarm records page;

2) Press to turn upper digit and press to turn lower digit in order to choose the record you need. Press to confirm the record and come into history records checking page.



3) Press to turn lower records under records checking page. Press to turn upper records and press to revert back to alarm history records page.

4) Exit from records page: In the history records page and checking page, press to exit;

9. Control and operation instruction

◆ Manual test mode: (only DC52D MK3 has this function)

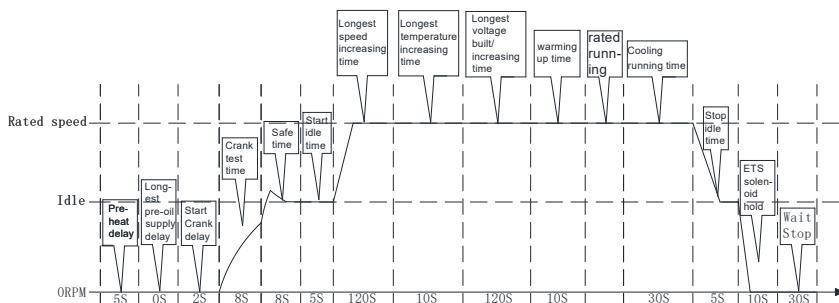

Press  and make sure it is in the stop position before starting.

Press  and the test file indicator is on. At this time, it is detected whether the connection of each sensor is normal. If the sensor is open, the sensor opens an alarm. If it is normal, the unit start process is executed in the following sequence after pressing the . automatically switch to Generator provide the power when the unit is running normally. Press  The controller performs the parking process at the following timing:





Manual Start Mode

press  and make sure it is in the stop position before starting.

Press  and the test file indicator is on. At this time, it is detected whether the connection of each sensor is normal. If the sensor is open, the sensor opens an alarm. If it is normal, the unit start process is executed in the following sequence after pressing the . automatically switch to Generator provide the power when the unit is running normally. Press  The controller performs the parking process at the following timing:

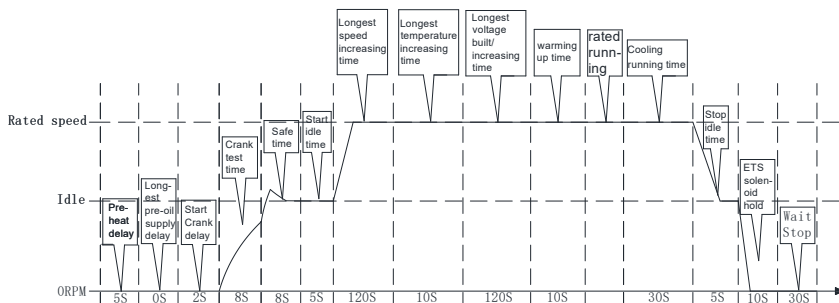
Manual start and stop process:



After the manual start is successful, pressing the "automatic key"  can be converted into an automatic file. The specific working time is as follows:

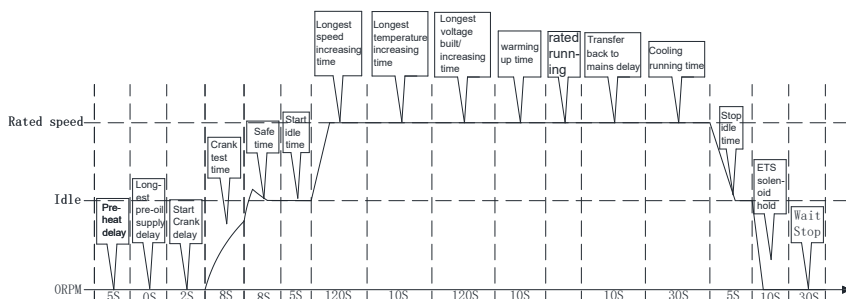

Automatic starting mode:

press and make sure it is in the stop position before starting.

Press and the test file indicator is on. At this time, it is detected whether the connection of each sensor is normal. If the sensor is open, the sensor opens an alarm. If it is normal, wait for the remote start signal to be valid (DC52D MK3 detected the remote starting signal is valid or the mains provide the power is invalid). The unit will perform the starting process in the following sequence. When the unit enters the normal rated operation, it will automatically switch to the generator provide the power. The controller will detect the remote start signal and the mains status in real time (DC52D MK3 is available). When the remote start signal fails and the mains provide the power returns to normal, the shutdown process after the "loop time delay" is performed (DC52D MK3 is available).

Auto start and stop process:

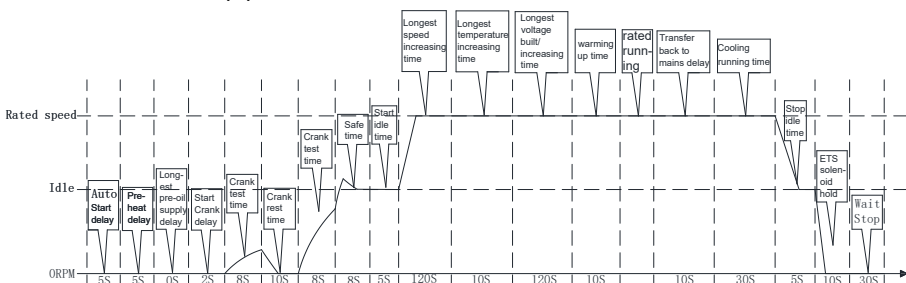

◆ Notices in Starting Process



Note 1: During the Cranking time, the controller automatically detects the speed signal, frequency signal and oil pressure value or the charging voltage (according to the parameter setting) to reach the judgment condition of successful start, then the judgment is that the start is successful and the motor relay is closed.



Note 2: Within the safety delay, only respond to emergency stop, immediate stop, over speed, over frequency, Over voltage, shutter open abnormal, other alarms are not responded to.



Note 3: No response to alarm and warning of under speed, low frequency,

under voltage, over current, over power, non-balance of current, external instant unloading shutdown, during start idle time.



Note 4: No response to low frequency, under voltage, over current non-balance of current, external instant unloading shutdown and over power is required when entering the RPM-up time.



Note 5: No response to low frequency, under voltage, over current non-balance of current, external instant unloading shutdown and over power is required when entering the temperature-up time.



Note 6: No response to low frequency, under voltage, over current non-balance of current, external instant unloading shutdown and over power is required when entering the Voltage-up time.



Note 7: No response to low frequency, under voltage, over current non-balance of current, external instant unloading shutdown and over power is required when entering the Warming-up time.



Note 8: After entering rated operation, the Gens load relay output.



Note 9: In the process of shutdown, if the remote starting signal is restored to be valid within the "Cooling time", the rated operation will be entered again.



Note 10: If the stop key is pressed again during idle time, the idle time will be canceled and the stop operation will be executed directly.

10. Warnings and Shutdown Alarms

◆ Warnings



Notes: Warning is a non-serious failure state, which will not harm the gensets system for the time being. It only reminds operators to pay attention to the situation that does not meet the requirements and solve it in time to ensure the continuous operation of the system. When the warning occurs, the gensets does not stop. Once the fault is removed, the warning is automatically canceled.

Low Oil Pressure Sensor Warning

When the controller parameter "**Action if low oil pressure**" is set to "**Warning**" and the AUX. INPUT port "**Low oil pressure shutdown disabled**" switch is valid, and the controller detects that the engine Oil Pressure is lower than "**Low oil pressure warning**", Then start warning delay and the duration (Normal alarm delay) have not returned to normal, the warning of low Oil Pressure is reported. "**WARNING**" lights will light up, Generators will not stop, displays "**Low OP sensor**" on the current fault screen.

Low Oil switch Warning

When the controller parameter "**Action if low oil pressure**" is set to "**Warning**" and the AUX. INPUT port "**Low oil pressure shutdown disabled**" switch is valid, and the

controller detects that the engine Oil Pressure is lower than "**Low oil pressure warning**", Then start warning delay and the duration (Normal alarm delay) have not returned to normal, the warning of low Oil Pressure is reported. "**WARNING**" lights will light up, Generators will not stop, displays "**Low OP Switch**" on the current fault screen.

High temperature sensor warning

When the controller parameter "**Action if high temperature**" is set to "**Warning**" and the AUX. INPUT port "**High temperature disabled**" switch is valid, and the controller detects that the coolant temperature value is higher than the "**High temperature warning**", Then start warning delay and the duration (Normal alarm delay) have not returned to normal, the warning of High coolant temperature warning is reported. "**WARNING**" lights will light up, Generators will not stop, displays "**High WT sensor**" on the current fault screen.

High temperature switch warning

When the controller parameter "**Action if high temperature**" is set to "**Warning**" and the AUX. INPUT port "**High temperature disabled**" switch is valid, and the controller detects that the coolant temperature value is higher than the "**High temperature warning**", Then start warning delay and the duration (Normal alarm delay) have not returned to normal, the warning of High coolant temperature warning is reported. "**WARNING**" lights will light up, Generators will not stop, displays "**High WT sensor**" on the current fault screen.

Low fuel level sensor warning

When the controller detects that the fuel level value is lower than the "**Low fuel level warning**", Then start warning delay and the duration (Normal alarm delay) have not returned to normal, the warning of Low fuel level warning is reported. "**WARNING**" lights will light up, Generators will not stop, displays "**Low fuel level-A**" on the current fault screen.

Low fuel level switch warning

When the controller detects that the AUX. INPUT "**Low fuel level warning input**" switch is active, it starts warning delay and lasts for Normal alarm delay. When the "**Low fuel level warning input**" switch is enabled, the engine low fuel level switch warning is reported. "**WARNING**" lights will light up, Generators will not stop, displays "**Low fuel level-D**" on the current fault screen.

External instant warning

When the controller detects that the AUX. INPUT "**External instant warning input**" switch is active, it starts warning delay and lasts for Normal alarm delay. When the "**External instant warning input**" switch is enabled, the warning is reported. "**WARNING**" lights will light up, Generators will not stop, displays "**Instant warn**" on the current fault screen.

Speed signal lost warning

When the controller parameter "**Action if RPM lost**" is set to "**warning**", the detected speed value is 0, Then start warning delay and the duration (Normal alarm delay) have not returned to normal, the warning of speed signal lost warning is reported. "**WARNING**" lights will light up, Generators will not stop, displays "**Lose speed**" on

the current fault screen.

Oil pressure sensor disconnected warning

When the controller parameter "**Action if low oil pressure sensor disconnected**" is set to "**warning**", When the oil pressure sensor is detected to be disconnected, Then start warning delay and the duration (Normal alarm delay) have not returned to normal, the warning of Oil pressure sensor disconnected warning is reported. "**WARNING**" lights will light up, Generators will not stop, displays "**OP sensor open**" on the current fault screen.

Coolant temperature sensor disconnected warning

When the controller parameter "**Action if water temperature sensor disconnected**" is set to "**warning**", When the coolant temperature sensor is detected to be disconnected, Then start warning delay and the duration (Normal alarm delay) have not returned to normal, the warning of coolant temperature sensor disconnected warning is reported. "**WARNING**" lights will light up, Generators will not stop, displays "**WT sensor open**" on the current fault screen.

Over battery voltage warning

When the controller detects that the battery voltage is higher than the "**Over battery voltage warning** ", Then start warning delay and the duration (Normal alarm delay) have not returned to normal, the warning of Over battery voltage warning is reported. "**WARNING**" lights will light up, Generators will not stop, displays "**Over voltage**" on the current fault screen.

External instant unloading switch warning

When the controller detects that the AUX. INPUT "**External instant unloading shutdown disabled**" switch is active, it starts warning delay and lasts for Normal alarm delay. When the "**External instant unloading shutdown disabled**" switch is enabled, the warning is reported. "**WARNING**" lights will light up, Generators will not stop, displays "**Unload switch**" on the current fault screen.

Fuel Level sensor disconnected warning

When the controller parameter "**Action if fuel Level sensor disconnected** " is set to "**warning**", When the fuel Level sensor is detected to be disconnected, Then start warning delay and the duration (Normal alarm delay) have not returned to normal, the warning of fuel Level sensor disconnected warning is reported. "**WARNING**" lights will light up, Generators will not stop, displays "**FL sensor open**" on the current fault screen.

Maintenance expiration warning

When the controller parameter "**Maintenance expire**" is set to "**warning**", when the primary countdown to maintenance is detected as "0" or primary maintenance date less than current date, then start warning delay and the duration (normal alarm delay), the warning of maintenance expiration is reported. "**WARNING**" lights on, without stopping the engine, and displays "**Maintain end**" on the LCD screen.

Low coolant level switch warning

When the controller detects that the AUX. INPUT "**Low water level warning**" switch is active, it starts warning delay and lasts for Normal alarm delay. When the "**Low**

water level warning" switch is enabled, the engine low coolant level switch warning is reported. **"WARNING"** lights will light up, Generators will not stop, displays **"Low water level"** on the current fault screen.

Over battery voltage warning

When the controller detects that the battery voltage is over than the **"Over battery voltage warning"**, Then start warning delay and the duration (Normal alarm delay) have not returned to normal, the warning of over battery voltage warning is reported. **"WARNING"** lights will light up, Generators will not stop, displays **"Over BATT volt"** on the current fault screen.

Under battery voltage warning

When the controller detects that the battery voltage is lower than the **"Under battery voltage warning"**, Then start warning delay and the duration (Normal alarm delay) have not returned to normal, the warning of Under battery voltage warning is reported. **"WARNING"** lights will light up, Generators will not stop, displays **"Under BATT volt"** on the current fault screen.

Charging failure warning

When the gap between D+ and B+ is over than this value, and there is charging failure but still high(normal warning delay), then charge failure warns. **"WARNING"** lights will light up, Generators will not stop, displays **"Charger fault"** on the current fault screen. Once the gap is lower than the value, warns clear.

◆ Starting fault

Fail to Start

If the number of cranks exceeds the predetermined number of cranks, the failure of start-up will be reported if the start-up of the generating unit is still unsuccessful. **"ALARM"** lights on, without stopping the engine, and displays **"Crank failure"** on the current fault screen.

◆ Shutdown Alarms



Warning: After the Shutdown Alarm occurs, the system will be locked immediately and the generator set will be stopped. Only after troubleshooting, press



key to clear the alarm, can it be re-operated.



Notes: When the shutdown alarm failure occurs, the **"ALARM"** lights will light up and the generator unit automatically stops.

Over speed alarm

When the controller detects that the engine speed is higher than **"Over speed alarm"**, Then start alarm delay and the duration (Emergency delay) have not returned to normal, the alarm of over speed is reported. **"ALARM"** lights flicker, Generator stops running, and displays **"Over speed"** on the current fault screen.

Under speed alarm

When the controller detects that the engine speed is under than "**Under speed alarm**", Then start alarm delay and the duration (Normal alarm delay) have not returned to normal, the alarm of under speed is reported. "**ALARM**" lights flicker, Generator stops running, and displays "**Under speed**" on the current fault screen.

Low oil pressure sensor alarm

When the controller detects that the engine Oil Pressure is lower than "**Low oil pressure alarm**", Then start alarm delay and the duration (Normal alarm delay) have not returned to normal, the alarm of low Oil Pressure is reported. "**ALARM**" lights flicker, Generator stops running, and displays "**Low OP sensor**" on the current fault screen.

Low oil pressure switch alarm

When the controller detects that the AUX. INPUT port "**Low oil pressure alarm input**" switch is active. Start low oil pressure switch alarm delay, for a period of time "general alarm delay" AUX. INPUT port "low oil pressure alarm input" switch is valid. Then the alarm, the public alarm light "**ALARM**" light is always on, stop the unit operation, and display "**Low OP switch**" on the current fault screen.

High temperature sensor alarm

When the controller detects that the temperature value is higher than the "**High temperature alarm**", Then start alarm delay and the duration (Normal alarm delay) have not returned to normal, the alarm of High temperature alarm is reported. "**ALARM**" lights will light up, Generator stops running, and displays "**High Temp sensor**" on the current fault screen.

High Temperature Switch Alarm

When the controller detects that the High temperature alarm switch input is valid to the ground, then start alarm delay and the duration (Normal alarm delay) have not returned to normal, the alarm of High Temperature Switch is reported. "**ALARM**" lights flicker, Generator stops running, and displays "**High Temp switch**" on the current fault screen.

Low fuel level sensor alarm

When the controller detects that the fuel level value is lower than the "**Low fuel level alarm**", Then start alarm delay and the duration (Normal alarm delay) have not returned to normal, the alarm of Low fuel level alarm is reported. "**ALARM**" lights will light up, Generator stops running, and displays "**Low fuel level-A**" on the current fault screen.

Low fuel level switch alarm

When the controller detects that the AUX. INPUT "**Low fuel level alarm input**" switch is active, it starts alarm delay and lasts for Normal alarm delay. When the "**Low fuel level alarm input**" switch is enabled, the engine low fuel level switch alarm is reported. "**ALARM**" lights will light up, Generator stops running, and displays "**Low fuel level-D**" on the current fault screen.

External instant alarm

When the controller detects that the “**External instant alarm input**” switch of the AUX. INPUT port is valid, the external instant trip is started and the shutdown alarm delay is delayed for a period of time “**Normal alarm delay**” AUX. INPUT port “**External instant alarm input**” switch When it is valid, it will alarm, the public alarm light “**ALARM**” lights will light up, Generator stops running, and display “**Instant parking**” on the current fault screen.

Speed signal lost alarm

When the controller parameter “**Action if RPM lost**” is set to “**alarm**”, the detected speed value is 0, Then start alarm delay and the duration (Normal alarm delay) have not returned to normal, the alarm of speed signal lost warning is reported. “**ALARM**” lights will light up, Generator stops running, displays “**Lose speed**” on the current fault screen.

Oil pressure sensor disconnected alarm

When the controller parameter “**Action if low oil pressure sensor disconnected**” is set to “**alarm**”, When the oil pressure sensor is detected to be disconnected, Then start alarm delay and the duration (Normal alarm delay) have not returned to normal, the alarm of Oil pressure sensor disconnected alarm is reported. “**ALARM**” lights will light up, Generator stops running, displays “**OP sensor open**” on the current fault screen.

Temperature sensor disconnected alarm

When the controller parameter “**Action if temperature sensor disconnected**” is set to “**alarm**”, When the temperature sensor is detected to be disconnected, Then start alarm delay and the duration (Normal alarm delay) have not returned to normal, the alarm of temperature sensor disconnected alarm is reported. “**ALARM**” lights will light up, Generator stops running, displays “**Temp sensor open**” on the current fault screen.

Fuel Level sensor disconnected alarm

When the controller parameter “**Action if fuel Level sensor disconnected**” is set to “**alarm**”, When the fuel Level sensor is detected to be disconnected, Then start alarm delay and the duration (Normal alarm delay) have not returned to normal, the alarm of fuel Level sensor disconnected alarm is reported. “**ALARM**” lights will light up, Generator stops running, displays “**FL sensor open**” on the current fault screen.

Over frequency alarm

When the controller detects that the generator frequency is higher than “**Over frequency alarm**”, Then start alarm delay and the duration (Emergency delay) have not returned to normal, the alarm of over frequency is reported. “**ALARM**” lights will light up, Generator stops running, displays “**Over frequency**” on the current fault screen.

Under frequency alarm

When the controller detects that the generator frequency is lower than “**Under frequency alarm**”, Then start alarm delay and the duration (Normal alarm delay) have not returned to normal, the alarm of under frequency is reported. “**ALARM**”

lights will light up, Generator stops running, displays " **Under frequency** " on the current fault screen

Over voltage alarm

When the controller detects that the generator voltage is higher than "**Over voltage alarm**", Then start alarm delay and the duration (Normal alarm delay) have not returned to normal, the alarm of over voltage is reported. "**ALARM**" lights will light up, Generator stops running, displays " **Over voltage** " on the current fault screen.

Under voltage alarm

When the controller detects that the generator voltage is lower than "**Under voltage alarm**", Then start alarm delay and the duration (Normal alarm delay) have not returned to normal, the alarm of under voltage is reported. "**ALARM**" lights will light up, Generator stops running, displays " **Under voltage** " on the current fault screen.

Over current alarm

When the controller detects that the generator phase current is higher than "**Phase current over-load alarm**", Then start alarm delay and the duration (Normal alarm delay) have not returned to normal, the alarm of over current is reported. "**ALARM**" lights will light up, Generator stops running, displays " **Over current** " on the current fault screen.

Over power alarm

When the controller detects that the generator power is higher than "**Over total power alarm**", Then start alarm delay and the duration (Normal alarm delay) have not returned to normal, the alarm of over power is reported. "**ALARM**" lights will light up, Generator stops running, displays " **Over power** " on the current fault screen.

Non-balance current ratio alarm

When the controller is 2 phase 3 wire or 3 phase 4 wire, the controller detects that the unbalance degree of the three-phase or two-phase current of the generator is higher than the "**Non-balance current ratio alarm**".Then start alarm delay and the duration (Normal alarm delay) have not returned to normal, the alarm of Non-balance current ratio is reported. "**ALARM**" lights will light up, Generator stops running, displays " **Unbalance of AMP** " on the current fault screen.

Maintenance Expiration Alarm

When the action after the primary maintenance expired set as "alarm", When the countdown to maintenance is detected as "0", Then start warning delay and the duration (Normal alarm delay) have not returned to normal, the warning of Maintenance expiration is reported. "**ALARM**" lights on, Generator stops running, and displays "**Maintain end**" on the current fault screen.

Low coolant level switch alarm

When the controller detects that the AUX. INPUT "**Low water level alarm**" switch is active, it starts alarm delay and lasts for Normal alarm delay. When the "**Low water**

level alarm" switch is enabled, the engine low coolant level switch alarm is reported. **"ALARM"** lights will light up, Generator stops running, displays **"Low water level"** on the current fault screen.

Louver opening exception alarm

When the controller detects that the AUX. INPUT **"Louver status input"** switch is active, it starts alarm delay and lasts for Normal alarm delay. When the **"Louver status input"** switch is enabled, the Louver status input alarm is reported. **"ALARM"** lights will light up, Generator stops running, displays **"Louver abnormal"** on the current fault screen.

Emergency stop alarm

When the controller detects that the input voltage of PIN 3 is less than 2V, then start alarm delay and the duration (Emergency delay) have not returned to normal, the alarm of Emergency Stop is reported. **"ALARM"** lights will light up, Generator stops running, and displays **"Emergency stop"** on the current fault screen.

Stop failure with frequency alarm

When the controller detects that the frequency is not "0" after the execution of the shutdown, the alarm of stop failure is reported. **"ALARM"** lights will light up and displays **"Stop fail-Hz"** on the current fault screen.

Stop failure with pressure alarm

When the controller detects that the Oil **Pressure** is not "0" after the execution of the shutdown, the alarm of stop failure is reported. **"ALARM"** lights will light up and displays **" Stop fail-OP-A "** on the current fault screen.













Stop failure with oil pressure switch

When the controller detects that the oil pressure switch has not returned after the stop, it will alarm, the public alarm light **"ALARM"** lights will light up, and the current fault screen displays **" Stop fail-OP-D"**.

11. Parameters setting

◆ Enter the edition page

Please set the parameters according to below steps:

- 1) The setting mode can be activated after pressing  and  simultaneously, under the status of standby without any alarm. The default password is **"07623"**.
- 2) Press  and add number 1, press  to reduce number 1, press  to turn the digit into right, press  to turn the digit into left, press  once done. Then system comes into menu after confirmation of password setting. The screen will display error if password is wrong. The correct password should be put after pressing any button.
- 3) Press  to turn the digit into upper position, press  to turn the digit into lower position, press  to get into parameters setting page.
- 4) Press  to shift up the parameters, press  to shift down the parameters, press  to get into parameter changing page.

5) Press to add number 1, press to reduce number 1, press to turn the digit into right and press to turn the digit into left, press once done. If the parameters setting is in the valid setting range, then it can be saved, if not, it can not be saved.

6) Press and to save the parameters and exit from edition page.

7) Press to revert back to last class if in any setting position.

Revert back to default: put password "97011" when coming into parameters setting, then all the parameters can be set as defaults.

Note: the data can't be saved if the user didn't press OK and STOP to confirm the setting.

◆ Parameter setting

1) Basic setting

No	Parameter	Range (default)	Notes
0	Language	0-English 1-简体中文 2-繁体中文 3-Русский 4-Espanol 5-Türk dili	Language option.
1	Gens poles	2/4/6/8(4)	When the flywheel teeth is set as 0, the RPM will be resulted by frequency. Pole 2: 50Hz---3000RPM. Pole 4: 50Hz--1500RPM. Pole 6: 50Hz---1000RPM. Pole 8: 50Hz--750RPM
2	Gens AC system	Disable 1 phase 2 wire 2 phase 3 wire 3 phase 3 wire 3 phase 4 wire	Gens phases: No gens parameters can be displayed if setting as disable, which is applied to water pump genset.
3	CT rate	5-6000A/5A(500A/5A)	Used for setting genset CT primary current, secondary rated current 5A.
4	Rated frequency	40.0-80.0Hz(50.0Hz)	Setting generator rated frequency to calculate the alarm value.
5	Rated phase voltage	80-360V(230V)	Setting generator phase voltage to calculate the alarm value.
6	Rated phase current	5-6000A(500A)	Setting generator phase current to calculate the alarm value.
7	Rated total power	5-2000Kw(276Kw)	Set total power of generator to calculate the average loading rate and alarm value.
8	Rated battery voltage	8.0-36.0V(24.0V)	Calculate the alarm value.
9	Rated RPM	500-4500RPM(1500)	Calculate the alarm value.
10	Flywheel teeth	0-300(0)	If the setting is 0, (RPM sensor Disabled), then RPM is resulted by Hz.

11	Oil pressure sensor	0: Disable 1: User defined-Resistance 2: User defined-Voltage 3: Volt In 1MPa-0-5V 4: Volt In 1MPa-0.5-4.5V 5: VDO 0-10Bar 6: MEBAY-003B 7: SGH 8: SGD 9: SGX 10: CURTIS 11:DATCON 10Bar 12: VOLVO-EC 13: 3015237 14: WEICHA1 0-0.6MPa 15: GENCON 0-10Bar	Choose the usual oil pressure sensor, if the sensor users choose is not the 9 types, it can be User-defined.
12	Temperature sensor	0: Disable 1: User-defined 2: VDO 40-120 °C 3: MEBAY-001B 4: SGH 5: SGD 6: SGX 7: CURTIS 8: DATCON 9: VOLVO-EC 10: 3015238 11:PT100 12: MEBAY-Mier 13: WEICHA1 40-120°C 14: GENCON 40-120°C	Choose the usual temperature sensor, if the sensor users choose is not the 11 types, it can be User-defined.
13	Fuel level sensor	0: Disable 1: User-defined 2: 0-100Ω 3: 100-0Ω 4: 0-107Ω 5: 107-0Ω 6: 0-180Ω 7: 180-0Ω 8: 180-10Ω 9: 10-180Ω 10: 120-10Ω 11:10-120Ω 12: 90-0Ω 13: 0-90Ω 14: 0-30Ω 15: 73-10Ω 16: 240-33Ω 17: 33-100Ω 18: 0-200Ω	If the sensor users choose is not the 3 types, it can be User-defined.

		19: 200-0Ω	
14	Action if RPM lost	Warning/Alarm and stop	The flywheel teeth is not 0 to detect this fault.
15	Action if low oil pressure	Warning Alarm and stop	If setting as warning,the AUX. INPUT should be set as Low oil pressure stop disabled and input is valid. When the oil pressure value is lower than the preset value or low oil pressure alarm input signal is valid, then controller only display warning but not stop.
16	Action if high temperature	Warning Alarm and stop Alarm and stop after unloading	Alarm and stop: when the temperature is higher than preset value or high temperature signal is valid, then controller will alarm and stop after normal faults delay. If setting as warning:the AUX. INPUT should be set as high temperature stop disabled and input is valid. When the temperature value is higher than the preset value or high temperature alarm input signal is valid, then controller only display warning but not stop. If setting as alarm and stop after unloading:the AUX. INPUT should be set as high temperature stop and input is valid. When the temperature value is higher than the preset value or high temperature alarm input signal is valid, then controller shall start the unloading procession and stop with alarm.
17	Action if oil pressure sensor disconnected	Disable Warning Alarm and stop	Action if oil temperature sensor disconnected.
18	Action if temperature sensor disconnected	Disable Warning Alarm and stop	
19	Action if fuel Level sensor disconnected	Disable Warning Alarm and stop	Action if Fuel level sensor disconnected.
20	Pressure/Temperature unit	°C/KPA °C/BAR °C/PSI °F/KPA °F/BAR °F/PSI	Unit display.

2)Basic Setting 2

NO	Parameter	Range(defaults)	Notes
1	Primary Modes	STOP Manual Auto Auto save	The primary modes on power, easy for user operation. Note: auto record function can not record the mode with load.
2	Manual crank times	1-30 (1 time)	Crank times under manual mode and test mode.
3	Auto start crank times	1-30 (3 times)	Crank times under auto mode.
4	E.T.S. hold times	1-10(2 times)	The max E.T.S. hold on power shall be canceled once stop success under auto mode . the output interval time is " Fail to stop ".
5	Crank disconnet	RPM Hz Oil pressure(delay) RPM/Frequency RPM/Oil Pressure Frequency/Oil Pressure RPM/Frequency/Oil press.	1.If there is no oil pressure sensor, please dont choose it. 2.Oil pressure switch input is not the crank condition 3.Please check if the running status, stop condition are according with crank condition. 4.Means either of the conditions can be acceptable as crank condition. But all of them should be meet together to regard as stop condition.
6	Frequency disconnect	0-200%(28%)	Rated frequency multiplying by this value is regarded as crank success condition. When the gens frequency is over the condition value, then system regards it as crank success.
7	Oil pressure disconnect	0-400kpa(200kpa)	When the engine oil pressure is over the condition value, then system regards it as crank success, motor escaped.
8	RPM disconnect	0-200%(24%)	Rated RPM multiplying by this value is regarded as crank success condition. When the RPM is over the condition value, then system regards it as crank success, motor escaped.
9	OP pre-supply stop	50-600kpa(200kpa)	When the oil pressure is over the condition value, then pre-oil supply is stopped.
10	RPM-up stop	0-200%(90%)	Rated RPM multiplying by this value is regarded as speed-up stop value. When the RPM is over this value, then the RPM-Up procession is stopped in time.
11	Temperature-up stop	20-200℃ (68 ℃)	When the temperature is over the preset value, then temperature-up procession is stopped in time.
12	Voltage-up stop	0-200%(85%)	Rated voltage multiplying by this value is regarded as voltage-up stop value. When the voltage is over this value, then the voltage-Up procession is stopped in time.
13	Fuel pump open	0-100%(25%)	When the fuel level is lower than preset value

			and remains 10S, fuel pump opened signal output
14	Fuel pump close	0-100%(80%)	When the fuel level is higher than preset value and remains 1S, fuel pump closed signal output.
15	Maintenance countdown	0-5000h(5000h)	When it is set as 5000, then this function is disabled.
16	Maintenance date	2000/01/01-2099/12/31	When it is set as 2000/01/01, this function is disabled.
17	Maintenance expire	Warning /Alarm and stop	The action after the primary maintenance expired.
18	User password	00000-65535(07623)	Change the password.
19	Battery charging start	8.0-30.0(25.6V)	When the battery voltage is lower than start value and remains 10s under non-running status, then the relay is opened. When it is higher than the close value and remains 10s, relay is closed. Once coming into running mode, there is no output.
20	Battery charging stop	10.0-36.0(27.8V)	
21	ATS in manual mode	Disable/Enable	When it is set to enabled, when the generator set meets the closing conditions, it will be loaded automatically.

3)Delay time setting

NO	Parameter	Range(default)	Notes
1	Start delay	0-6500.0s(5.0s)	The time during the genset starts after the mains failure or remote signal is valid.
2	Preheat time	0-6500.0s(0.0s)	The time needed to be preheat before the starter on power.
3	Longest pre-oil supply	0-180.0s(0.0s)	Under pre-oil supply, if the oil pressure is higher than setting value, then pre-oil supply stopped.
4	Cranking time	3.0-60.0s(8.0s)	The time when the starter is on power.
5	Crank rest time	3.0-60.0s (10.0s)	If crank failure, the waiting time before the second test time.
6	Oil pressure delay	0-20.0s(0.0s)	When the crank condition contains oil pressure, if the oil pressure is higher than the preset value and continue for few seconds, then it is regarded as crank success.
7	Safety delay	1.0-60.0s(8.0s)	Low oil pressure, high temperature, under speed, under frequency, under voltage, charge failure are all invalid during this time except for emergency stop ,over speed, over freq.
8	Start idle time	0-3600.0s(5.0s)	Idle running time when crank successfully.
9	Longest RPM-up time	0-3600.0s (120.0s)	The longest speed-up time,during which time the system will exit once speed increased successfully .
10	Longest Temp.-up time	0-3600.0s(0.0s)	The longest warming-up time,during which time the system will exit once temperature increased successfully .
11	Longest Volt.-up time	0-3600.0s (120.0s)	The longest voltage-up time,during which time the system will exit once voltage increased successfully .
12	Warming-up	0-3600.0s	The time needed for loading.

	time	(10.0s)	
13	Back to Mains time	0-3600.0s (10.0s)	To avoid the switch actions if the mains unstable.If the remote start signal is invalid (DC5XD MK3 will check if the mains normal), genset will not switch immediately, after the delay time, it will transfer to mains. during the delay, if the remote start signal is valid, then genset will come into rated running.
14	Back to Gens time	0-3600.0s (5.0s)	There shall be loading delay from Mains to Gens if the remote start signal valid or Mains abnormal under Cooling time.
15	Cooling time	0-3600.0s (30.0s)	After unloading, the time of cooling down by radiator before stop. During the delay, if the remote start signal is valid, then genset will come into rated running.
16	Stop idle time	0-3600.0s (5.0s)	Idle-speed running time.
17	E.T.S. hold time	0-600.0s (10.0s)	Stop solenoid on power time.
18	Fail to stop	5-180.0s (30.0s)	If the RPM is 0 during the stop failure time, then the stop failure time is no needed.
19	Emergency delay	0-10.0s (1.5s)	Emergency and over frequency alarm delay.
20	Normal alarm delay	2.0-20.0s (5.0s)	The alarm delay except for emergency stop and over frequency
21	Normal warning delay	1.0-20.0s (2.0s)	The warning delay.
22	AC Voltage abnormal delay	2.0-20.0s (10.0s)	Over / under voltage delay.
23	Over current 【inverse time】	0.1-36.0 (36.0)	This option will not take effect until the [27-Over phase current delay] is set to 0 . The overcurrent delay is inverse time, and the formula is $T=t/((IA/IT) -1)^2$.
24	Over power 【inverse time】	0.1-36.0 (36.0)	This option will not take effect until the [28-Over total power delay] is set to 0 . The over power delay is inverse time, and the formula is $T=t/((IA/IT) -1)^2$.
25	Transfer switch delay	0-3600.0s (1.0s)	The time from Mains to Gens.
26	Load / unload pulse width	1.0-10.0s (10.0s)	Mains and Gens loading and unloading pulse width, when it is 10s, it is regarded as continuous output.
27	Over phase current delay	0-3600.0s(30s)	When this parameter is set to 0, the over current delay is the inverse time; if not, the over current delay is the time set for this parameter.
28	Over total power delay	0-3600.0s(30s)	When this parameter is set to 0, the over power delay is the inverse time; if not, the over current delay is the time set for this parameter.
29	Fuel output delay	1.0-60.0s(2.0s)	The output time of fuel valve relay before crank.

4)Engine Alarm setting

NO	Parameter	Range (defaults)	Notes
1	Over speed	0-200%	Rated RPM multiplying by this value is regarded as

	alarm	(114%)	over speed alarm value. When the RPM is higher than the alarm value and comes into over speed delay but still higher (emergency faults delay), then over speed alarms. if the value is set as 200, then the over speed alarm is disabled.
2	Under speed alarm	0-200% (80%)	Rated RPM multiplying by this value is regarded as under speed alarm value. When the RPM is lower than the alarm value and comes into under speed delay but still lower (normal faults delay), then under speed alarms. if the value is set as 0, then the under speed alarm is disabled.
3	Low oil pressure alarm	0-999kpa (103kpa)	When the oil pressure is lower than the alarm value and comes into low oil pressure delay but still lower (normal faults delay), then low oil pressure alarms. If the value is set as 0, then the under speed alarm is disabled.
4	High temperature alarm	20-200°C (98 °C)	When the temperature is higher than the alarm value and comes into high temperature delay but still higher (normal faults delay), then high temperature alarms. If the value is set as 200, then the high temperature alarm is disabled.
5	Low fuel level warning	0-100% (20%)	When the fuel level is lower than the value and comes into low fuel level warning delay but still lower (normal warning delay), then low fuel level warns. If it is higher than the value then warning clears. If the value is set as 0, then the low fuel level warning is disabled.
6	Low fuel level alarm	0-100% (0%)	When the fuel level is lower than the alarm value and comes into low fuel level delay but still lower (normal faults delay), then low fuel level alarms. if the value is set as 0, then the under speed alarm is disabled.
7	Over battery voltage warning	0-200% (135%)	Rated battery voltage multiplying by this value is regarded as over battery voltage warning value. When the battery input is higher than the warning value and comes into over battery voltage delay but still higher (normal faults delay), then over battery voltage warns. if the value is set as 200, then the over battery voltage is disabled.
8	Under battery voltage warning	0-200% (100%)	Rated battery voltage multiplying by this value is regarded as under battery voltage warn value. When the battery input is lower than the warning value and comes into under battery voltage delay but still lower (normal faults delay), then under battery voltage warns. if the value is set as 0, then the under battery voltage is disabled.
9	Engine charger warning	1.0-30.0V (30.0V)	When the gap between D+ and B+ is over than this value, and there is charging failure but still high (normal warning delay), then charge failure warns. Once the gap is lower than the value, warns clear. If the value is set as 300, then the charge failure is disabled.

5) Generator alarm parameters

NO	Parameter	Range(<i>defaults</i>)	Notes
1	Over freq alarm	0-200% (114%)	Rated frequency multiplying by this value is regarded as under over frequency alarm value. When the Freq is higher than the value and comes into over freq delay but still higher (emergency faults delay), then over frequency alarms.If the value is set as 200, then the alarm is disabled.
2	Under freq alarm	0-200% (80%)	Rated frequency multiplying by this value is regarded as under frequency alarm value. When the Freq is lower than the value and comes into under freq delay but still lower (normal faults delay), then under frequency alarms.If the value is set as 0, then the alarm is disabled.
3	Over voltage warning	0-200% (120%)	Rated voltage multiplying by this value is regarded as over voltage alarm value. When the voltage is higher than the value and comes into over voltage delay but still higher (normal faults delay), then over voltage alarms.If the value is set as 200, then the alarm is disabled.
4	Under voltage alarm	0-200% (80%)	Rated voltage multiplying by this value is regarded as under voltage alarm value. When the voltage is lower than the value and comes into under voltage delay but still lower (normal faults delay), then under voltage alarms.If the value is set as 0, then the alarm is disabled.
5	Phase current over-load alarm	0-200% (100%)	Rated current multiplying by this value is regarded as over current alarm value. When the current is higher than the value and comes into over current delay but still higher (over current faults delay), then over current alarms.If the value is set as 200, then the alarm is disabled.
6	Non-balance current ratio warning	10-100% (100%)	It is valid for 2P3W or 3P4W.When the non-balance current ratio is higher than the value and comes into delay but still higher(normal warn delay), then non-balance current ratio warns.If the value is set as 100, then the warning is disabled.
7	Over total power alarm	0-200% (100%)	Rated power multiplying by this value is regarded as over power alarm value. When the loading power is higher than the value and comes into delay but still higher (power faults delay), then over power alarms..If the value is set as 200, then the alarm is disabled.

6)Output / Input setting

NO	Parameters	Range(<i>defaults</i>)	Notes
1	AUX. OUTPUT 1 (Functional of PIN 6)	0-50 (17. E.S.T. hold)	0. Disable. 1. Public warning output: when there is any warning output.
2	AUX. OUTPUT 2 (Functional of PIN 7,8,9)	0-50 (10.Idle speed control)	2. Public alarm output: when there is any alarm output, alarm locks till revert back. 3. Audio alarm: when there is any alarm

3	AUX. OUTPUT 3 (Functional of PIN 10,11)	0-50 (14. Gens load)	output, the Audio controls. 4. Shades control: there is output once genset starts and stop till stable.
4	AUX. OUTPUT 4 (Functional of PIN 12,13)	0-50 (23. Mains load)	5. Preheat mode 1: preheat before start. 6. Pre-oil supply control: Under pre-oil supply,if the oil pressure is higher than setting value or pre-oil supply time ends, then pre-oil supply stopped. 7. Fuel output: output once gens starts and off till stable. 8. Crank output: output once cranking, no output in other mode. 9. Genset running: output under running,off once RPM is lower than cranking RPM. The crank success condition can be set. 10. Idle speed control 1: used for speed controller, there is output under idle but no output under high speed. 11. Speed-up control: during the procession of speed increasing, the output time is the Longest RPM-up time. 12. High speed control: The output is valid after idle delay is completed, and the output is closed after high-speed heat dissipation. 13. Excitation output: there is output during cranking procession and there is 2s output if there is no frequency under high speed status. 14. Gens load: continuous or pulse type according to time setting. 15. Gens unload: continuous or pulse type according to time setting. 16. Speed-down control: the output time is shutdown idle delay during shutdown idle or shutdown on power procession. 17. E.S.T. hold: shutdown output, it is used for gens with stop solenoid. when the setting value of shutdown delay is over, then it is off. 18. System in stop: there is output under stop mode. 19. System in manual: there is output under manual mode. 20. System in auto: there is output under auto mode. 21. Fuel pump output: there is output if the oil capacity is lower than start condition for 10s and shutdown if it is higher than the shutdown condition for 1s. 22. Battery charging control: there is output

			<p>if the voltage is lower than the preset value under standby status and shutdown after start and in running status.</p> <p>23. Mains load: continuous or pulse type according to time setting. Only for DC52D MK3.</p> <p>24. Mains unload: continuous or pulse type according to time setting. Only for DC52D MK3.</p> <p>25. Idle speed control 2: used for speed controller, there is output under idle but no output under high speed.</p> <p>26. Rated running: there is output under rated running.</p>
5	AUX. INPUT 1 (Functional of PIN 20)	0-40(2.High temperature alarm)	0. Disable.
6	AUX. INPUT 2 (Functional of PIN 21)	0-40(1.Low oil pressure switch)	1. Low oil pressure alarm switch.
7	AUX. INPUT 3 (Functional of PIN 22)	0-40(27.Remote start)	2. High temperature alarm switch.
8	AUX. INPUT 4 (Functional of PIN 38)	0-40(8.Low Fuel level warning input)	3. Low water level warning switch.
9	AUX. INPUT 5 (Functional of PIN 39)	0-40(6.Low water level alarm input)	4. Low water level alarm switch.
			5. Low fuel level warning input.
			6. Low fuel level alarm input.
			7. Charging failure warning: output when charging failure.
			8. Low oil pressure shutdown disabled: valid if there is signal input.
			9. High temperature shutdown disabled: valid if there is signal input.
			10. External instant warning input.
			11. External instant alarm input.
			12. Gens un/loading input: connect to the gens loading switches auxiliary point.
			13. Mains un/loading input: connect to auxiliary point of mains loading switch.(Only for DC52D MK3).
			14. Shades status input.
			15. Auto start disabled: gens will not start if there is signal input whatever mains normal or not.
			16. Auto stop disabled: gens will not stop if there is signal input whatever mains normal or not.
			17. Stop by radiator if high temperature: The controller will shutdown the gens after high speed cooling down delay when temperature is too high if this signal is valid and gens under normal running . the controller will shutdown the gens directly if the signal is not valid.
			18. Remote start(with load): the gens comes into start procession if this signal is valid and under auto mode.

			<p>19. Soundproof alarm: audio alarm output is disabled if there is signal output.</p> <p>20. Front face button disabled: any button except for page button is disabled if there is signal output.</p> <p>21. Meter mode: all output are disabled, alarm and warns are invalid. any button except for page button is disabled.</p> <p>22. Remote control mode: any button except for page button is disabled if the input is valid, LCD will display remote mode. remote control module can start/stop and monitor parameters through front face buttons.</p> <p>23. – 40. Reserved.</p>
10	AUX. INPUT 1 valid	0- Normal close 1- Normal open	The status of switch value input valid.
11	AUX. INPUT 2 valid	0- Normal close 1- Normal open	
12	AUX. INPUT 3 valid	0- Normal close 1- Normal open	
13	AUX. INPUT 4 valid	0- Normal close 1- Normal open	
14	AUX. INPUT 5 valid	0- Normal close 1- Normal open	

7) Working plan and maintenance setting

NO	Parameter	Range(defaults)	Notes
1	Working plan format	Disable Every month Every week	This mode must be under auto mode. Working plan is disabled once setting as disable. The working plan will be executed according the chosen date when setting as every month. The working plan will be executed according the chosen date when setting as every week.
2	Maintenance date per month	From 1 st to 31 st Default: the first day	The date chosen for every month.
3	Maintenance date per week	Monday to Sunday Default: Sunday	The date chosen for every week.
4	Maintenance with load or not	Disabled/with load	To choose if the genset starts with load or not.
5	Maintenance start time	00:00-23:59(00:00)	Maintenance start time setting.
6	Maintenance running time	1-120m(5m)	Maintenance running time setting.

8) Mains protection

No	Parameter	Range(defaults)	Notes
1	Phase	Disable 1 Phase 2 Wire 2 Phase 3 Wire	Choose the input, there is no display if setting as disable.

		3 Phase 3 Wire 3 Phase 4 Wire	
2	Mains under volt	55-330V(184V)	When the mains voltage is lower than the "low voltage crank threshold" and comes into mains low voltage delay(normal failure delay) but still lower, then mains becomes invalid. If the voltage become higher than "low voltage revert threshold" during normal failure delay time, then it will not alarm.
3	Revert under volt	55-330V(207V)	
4	Mains over volt	55-330V(276V)	When the mains voltage is higher than the" high voltage crank threshold" and comes into mains high voltage delay(normal failure delay) but still higher, then mains becomes invalid. If the voltage become lower than "low voltage revert threshold" during normal failure delay time, then it will not alarm.
5	Revert over volt	55-330V(253V)	
6	Mains normal delay	0.0-3600.0S (10.0S)	The time from abnormal to normal, which is used for ATS transfer.
7	Mains abnormal delay	0.0-3600.0S (5.0S)	

9) LCD setting

No	Parameter	Range(defaults)	Notes
1	Start screen display	0-20.0s(5.0s)	Start screen display time,0: No-display.
2	Saving mode	5.0-6000.0s (600.0s)	LCD light will be closed automatically without any button pressed after delay.If setting as 200.0s, back light always lighted.
3	Homing display	5.0-600.0s (600.0s)	The time when the page reverts back to the home page .If setting as 600.0s:disabled.
4	LOGO delay display under standby	5.0-6000.0 (6000.0s)	Start screen will be opened without any button pressed after delay.If setting as 6000.0s: disabled.
5	LCD contrast	50-128(82)	Set the LCD display contrast.

a) USB/RS485 PORT

No	Parameter	Range(default)	Notes
1	Controller address	1-255(16)	The IP built by controller and PC.
2	RS485 baud rate	0-4800 1-9600 2-19200 3-38400 4-57600 5-115200	RS485 communication baud rate.
3	CRC setting	CRC: L_H CRC: H_L	RS485 communication CRC correction high and low bits

b) Working plan

No	Parameter	Range(default)	Notes
1	Working plan	Disable Enable 1:remote start Enable 2:mains failure Enable 3:the above 1 or 2 Enable 4:running always	Working plan must be under auto mode.During the working time, the genset start if the conditions reached and shall stop if the conditions not reached. The genset shall not start when out of the

			working time wheather the conditions reached or not.
2	Start time	00:00-23:59	The start time allowed.
3	End time	00:00-23:59	The end time allowed(the next day is valid)..
4	Dates	1-31	Multiple choices according to the reality. The longest running time is 24 hours.

c) Data/time setting

No	Parameter	Range(defaults)	Notes
1	Date	2016/01/01-2099/12/31	Permanent calendar inside, please correct the time timely.
2	Current time	00:00:00-23:59:59	Permanent calendar inside, please correct the time timely.

d) Self-define curve

NO	Parameter	Notes
1	Self-define oil pressure resistance curve	Sensor curve can be User-defined by panel buttons, resistance and according value should be input, MAX 15 groups, MIN 2 groups.  Rule: resistance should be input from small to large.
2	Self-define oil pressure voltage curve	
3	Self-define water temperature curve	
4	Self-define fuel level curve	

12. Fault finding

Symptoms	Possible Solutions
Controller no response with power	Check DC voltage. Check DC fuse. Check if the terminal 1 and 2 is with battery voltage.
Genset shutdown	Check the water/cylinder temperature is too high or not. Check the genset AC voltage. Check DC fuse.
Genset Emergency Stop	Check the emergency stop button. Check that the voltage of the controller's 3 feet to the ground should be the battery voltage. Check the controller connection.
Low oil pressure alarm	Check oil pressure sensor and its wiring. Check the oil pressure sensor type and controller settings must be consistent. Check whether the low oil pressure sensor is normal.
High temperature alarm	Check temperature sensor and its wiring. Check the temperature sensor type and controller settings must be consistent. Check whether the temperature sensor is normal.
Shutdown Alarm in running	Check related switch and its connections according to the information on LCD. Check AUX. INPUTs.
Fail to start	Check fuel return circuit and wiring. Check start battery. Consult engine manual.
Starter motor does not respond	Check the wiring to the starter. Check start battery.

Unit operation but ATS does not switch	Check the ATS. Check the cable between the controller and the ATS.
USB communication is abnormal	Check the USB connection. Check whether the USB port of the computer is normal. Check whether the USB driver is installed.
RS485 cannot communicate normally	Check the connection. Check if the communication ID number setting is correct. Check if the A and B lines of RS485 are reversed. Check if the RS485 communication line driver is installed or not. Check if the communication port of the PC is damaged. Add a 120 Ω resistor between the AB of the controller RS485.