

DC4xS/C GENSET CONTROLLER USER MANUAL

DC40S/C



DC42S/C



Software Version

No.	Version	Date	Note
1	V1.0	2021-02-01	Original release.
2	V1.1	2022-01-24	Increase the charging coil signal detection function; Increase public open-circuit output, mains phase loss setting
3	V1.2	2022-04-07	Increase the relay output function;
4	V1.3	2022-07-20	Additional models: DC42ST, DC42STR;
5	V1.4	2022-09-01	Add the system log function, increase the number of alarm records, add the recovery hysteresis width of over-current and over-power alarm, and add the remote start without load function for the switching value input. Add Emergency start function. Add display language: Français. DC40S/C adds mains power detection function. Correct the AC voltage input range.
6	V1.5	2022-12-20	Add display language: Polski.
7	V1.6	2023-05-08	Add display language: Português, Românesc
8	V1.7	2023-12-11	Increase speed changeover setting. Add languages: German, Korean, Vietnamese, Arabic, BahasaIndonesia, Persian.



Chongqing Mebay Technology Co.,Ltd

Add: No6-2,Building 4, Gangan Rd, Jiangbei District, Chongqing.

Tel: +86-23-6869 3061



Fax: +86-23-6765 8207

Web: <http://www.mebay.cn>

<http://www.cqmb.cn>

E_mail: sales@mebay.cn

Symbol Description

Symbol	Description
 Note	Remind operators to operate correctly, otherwise it may cause the equipment not to work correctly.
 Be care	It is indicated that potential hazards can damage equipment without proper precautions.
 Warning	It is indicated if appropriate preventive measures are not taken, potentially dangerous situations may result in death, serious personal injury or significant property losses.

**Warning**

1. The installation of this equipment must be carried out by professionals.
2. When installing and operating the controller, please read the entire instruction manual first.
3. Any maintenance and commissioning of the equipment must be familiar with all the equipment.
4. Safety standards and precautions in advance, otherwise it may cause personal injury or damage to related equipment.
5. The engine must have an overspeed protection device independent of the controller system to avoid casualties or other damage caused by engine out of control.
6. After the installation of the controller is completed, please verify that all protection functions are valid.

**Be Care**

1. Please keep the good connection of the power supply of the controller. Do not share the connection lines of the positive and negative electrodes of the battery with the floating charger.
2. During the operation of the engine, do not disconnect the battery, otherwise it may cause damage to the controller.

CATALOGUE

1. Summary	5
2. Main Features	5
3. Parameters Display	6
4. Protection	7
5. Parameters	7
6. Overall Dimension and Wiring Diagram	8
7. Installation instruction	18
8. Panel and display	19
9. Control and operation instruction	22
10. Warnings and Shutdown Alarms	24
11. Parameters setting	32
12. Fault finding	47

Notes:

1. All rights reserved. No part of this duplication may be reproduced in any material form (including photocopying or storing in any medium by electronic means or others) without the written permission of the copyright holder.
2. MEBAY Technology reserves the rights to change the contents of this document without prior notice.

1. Summary

This series controller is specialized for Diesel / Gasoline / Gas Genset Start, Stop, Parameters monitoring, faults-checking as well as data setting.

2.8 inch LCD screen display with brand new UI design is adapted in this controller that the relative failures can be displayed directly. All the parameters can be displayed by simulated indicators and words. Besides, LCD screen can display various faults in the same time that the genset will be stopped once it can't work smoothly.

There are Chinese/English interface options, more language can be set according to user's request. All the parameters can be configured through the front face buttons or use programmable interface by RS485 or USB to adjust via PC. It can be widely applied for all kinds of auto control system of gensets.

2. Main Features

There are ten Models under DC4xS/C series.

DC40S: Used for single machine automation. Start/Stop through remote start signal.

DC40SR: Based on DC40S, it adds RS485 port.

DC42S: Based on DC40S, it adds Mains monitoring and AMF (Mains/Generator automatic switching control), especially suitable for the automation system composed by mains and genset.

DC42SR: Based on DC42S, it adds RS485 port.

DC40C: Used for single machine automation. Start/Stop through remote start signal. it adds CAN port.

DC40CR: Based on DC40C, it adds RS485 port.

DC42C: Based on DC40C, it adds Mains monitoring and AMF (Mains/Generator automatic switching control), especially suitable for the automation system composed by mains and genset.

DC42CR: Based on DC42C, it adds RS485 port.

DC42ST: Based on DC42S, it is changed to 50mA small transformer to adapt to small units;

DC42STR: Based on DC42ST, it adds RS485 port.

- ◆ 32bit high performance single chip microcomputer.
- ◆ 2.8 inch 240 * 128 high-resolution LCD screen, Available in 6 languages, user's language set if necessary.
- ◆ Indicator and number display through UI surface.
- ◆ Acrylic material is adapted to protect the screen.
- ◆ Silicone panels;
- ◆ USB Port: parameters can be set even without power through USB port to monitor in real time.
- ◆ With RS485 communication port, can achieve "Three Remote" functions via MODBUS protocol.
- ◆ Standard CAN communication port, built-in J1939 protocol, has matched more than 40 kinds of engines;
- ◆ Various kinds of parameters display.

- ◆ Input/output function, status can be shown directly.
- ◆ Real time clock inside: preset time operate and auto maintenance is available. Genset working plan can be set as per week or month.
- ◆ Maintenance countdown function, can set maintenance time or date.
- ◆ The black box function can save the relevant parameters of the unit when the fault alarm occurs in real time, and it is convenient to find the cause of the fault.
- ◆ Totally 6 relay's output, among which 4 relay output can be self-configurable, each relay can be set as max 20 functions.
- ◆ With 4 switches input, up to 20 functions optional;
- ◆ 3 sensor simulation input connectors, the oil pressure sensor is compatible with voltage signal input, and various display units can be configured.
- ◆ Battery charging control function, which can protect the battery according to battery voltage status.
- ◆ Sensor can be self-defined by front face button or PC software.
- ◆ Adapt to 3P4W, 1P2W, 2P3W (120V/240V, 50/60HZ)
- ◆ Various of crank conditions (RPM, Frequency, Oil Pressure) can be chosen.
- ◆ Control Protection: Auto Start/Stop of genset, load transfer (ATS control) and perfect failure display and protection.
- ◆ Standard water-proof rubber gasket. The waterproof can reach IP65.
- ◆ Module design: All the connections are adapted with European connectors so that installation, connection, repair and replacement can be more easily.

3. **Parameters Display**

- ◆ Engine RPM
- ◆ Engine oil pressure
- ◆ Engine temperature
- ◆ Engine fuel level
- ◆ Engine battery voltage
- ◆ Charging voltage
- ◆ CAN related parameters (C series only)
- ◆ Mains Frequency (only for DC42S/C)
- ◆ Mains phase voltage L-N (only for DC42S/C)
- ◆ Mains phase voltage L-L (only for DC42S/C)
- ◆ Generator 3 Phase voltage L-N
- ◆ Generator 3 Phase voltage L-L
- ◆ Generator 3 phase current A
- ◆ Generator Frequency Hz
- ◆ Generator Power Factor COS ϕ
- ◆ Generator active power KW
- ◆ Generator apparent power KVA
- ◆ Generator reactive power KVar
- ◆ Real-time load rate %
- ◆ Current load rate %
- ◆ Average loading rate %
- ◆ Current consumption KWH

- ◆ Total consumption KWH
- ◆ Total Crank times
- ◆ Cumulative power on time of controller
- ◆ Current running time
- ◆ Total running time
- ◆ Maintenance notice
- ◆ Switches input status display
- ◆ Output status display of relays
- ◆ Current date and time;

4. Protection

- ◆ Over speed
- ◆ Under speed
- ◆ Low oil pressure
- ◆ High temperature
- ◆ Low fuel level
- ◆ External emergency alarm
- ◆ D+ open
- ◆ RPM Lost
- ◆ Sensor Open
- ◆ Over Frequency
- ◆ Under Frequency
- ◆ Over voltage
- ◆ Under voltage
- ◆ Over current
- ◆ Non-balance of current
- ◆ Over power
- ◆ Maintenance expire
- ◆ Low water level alarm
- ◆ Emergency Stop
- ◆ Crank failure
- ◆ Battery over voltage
- ◆ Battery under voltage
- ◆ The charger fails to charge
- ◆ Charger charging failure
- ◆ Stop Failure
- ◆ ECU alarm failure
- ◆ ECU communication Failure

5. Parameters

Options	Parameters
Working voltage	DC8V----36V Continuous
Power consumption	Standby: 24V: MAX 2W
	Working: 24V: MAX5W
AC Voltage Input	1P2W 30VAC-360VAC (ph-N)
	2P3W 30VAC-360VAC (ph-N)
	3P4W 30VAC-360VAC (ph-N)

Rotate speed sensor Frequency	50-10000Hz
MAX Accumulating Time	99999.9Hours (Min Store time:6min)
Fuel Relay Output	Max 5Amp DC+VE Supply voltage
Start Relay Output	Max 5Amp DC+VE Supply voltage
AUX.OUTPUT 1	Max 1Amp DC+VE Supply voltage
AUX.OUTPUT 2	Max 1Amp DC+VE Supply voltage
AUX.OUTPUT 3	Max 1Amp DC+VE Supply voltage
AUX.OUTPUT 4	Max 1Amp DC+VE Supply voltage
Excitation output	DC+VE supply voltage
AUX. Input	Available if connecting with Battery -
Working condition	-25-65°C
Storage condition	-40-85°C
Protection Level	IP65: when waterproof rubber gasket is added between controller and its panel
Insulation strength	Apply AC2.2kV voltage between high voltage terminal and low voltage terminal; The leakage current is not more than 3mA within 1min.
Overall dimension	142mm*105mm*45mm
Panel cutout	116mm*90mm
Weight	0.6Kg

6. Overall Dimension and Wiring Diagram

◆ Overall Dimension:



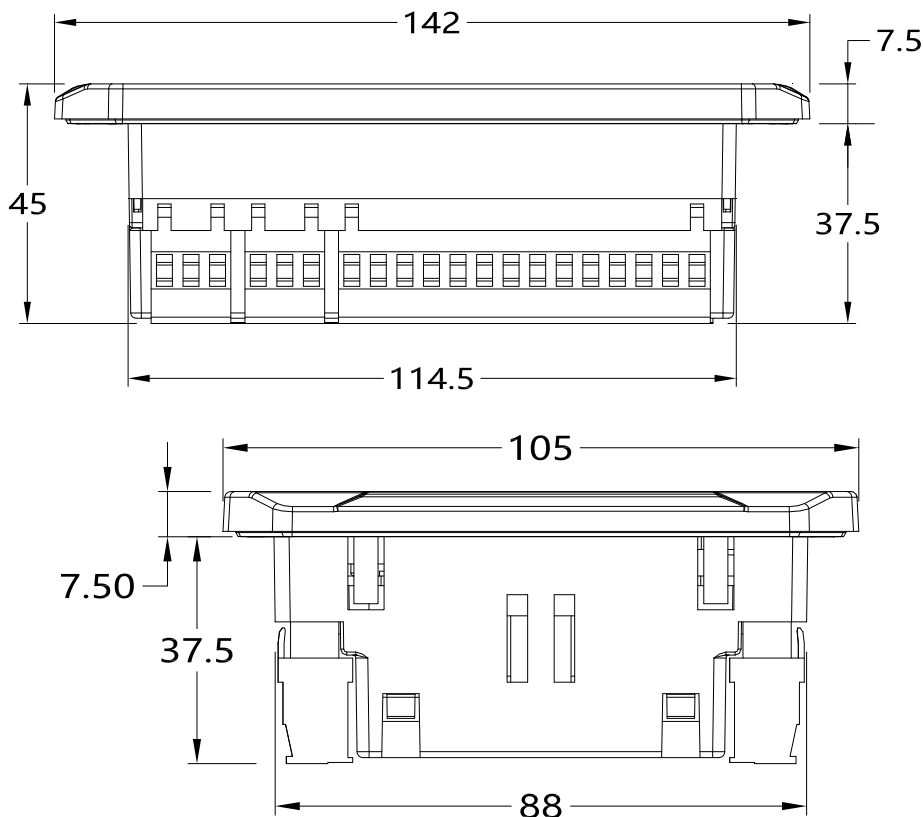

◆ Descriptions of terminal connection

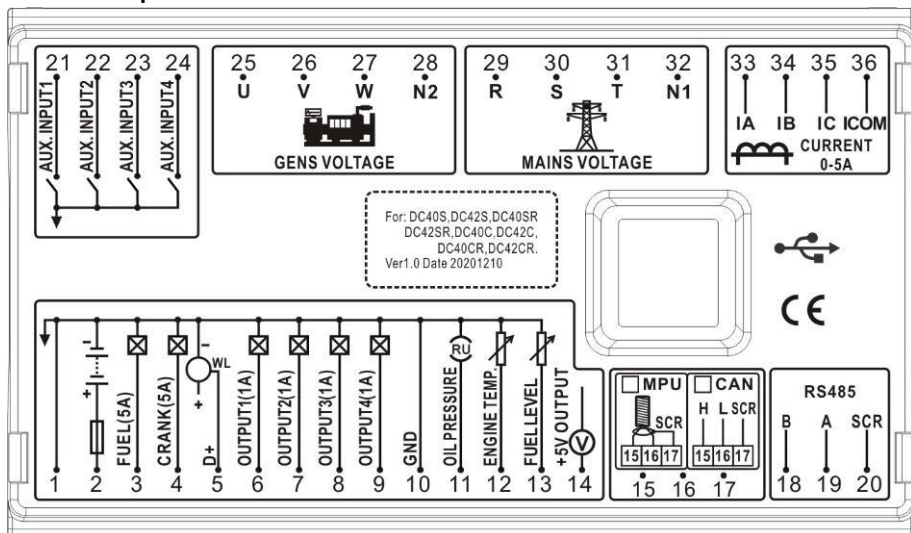

No.	Function	Description	Cable cross sectional area
1	Battery Negative Input B-	Controller power supply input B-.	2.5mm ²
2	Battery Negative Input B+	Controller power supply input B+.	2.5mm ²
3	Fuel Output	+VE output, Max 5Amp	1.5mm ²
4	Crank Output	+VE output, Max 5Amp.	1.5mm ²
5	Charging excitation output	+VE output, Max 0.9Amp.	1.0mm ²
6	Aux. Output 1	+VE output, Max 1Amp.	1.0mm ²
7	Aux. Output 2	+VE output, Max 1Amp.	1.0mm ²
8	Aux. Output 3	+VE output, Max 1Amp.	1.0mm ²
9	Aux. Output 4	+VE output, Max 1Amp.	1.0mm ²
10	Sensor common GND	Connect the battery negative or outer.	1.0mm ²
11	Oil pressure sensor	Connect sensor input.	1.0mm ²
12	Temperature Sensor	Oil pressure sensor compatible with resistance/voltage sensors;	1.0mm ²
13	Fuel level sensor		1.0mm ²
14	+5V Output	Connect the power supply of the oil pressure sensor with the output voltage signal, with a maximum of 50mA.	1.0mm ²
15	Speed sensor +	Use a shielded wire to connect the speed sensor.	1.0mm ²
16	Speed sensor -		1.0mm ²
17	Speed sensor SCR		1.0mm ²
15	CAN_H	A 120 Ω shielded wire and good grounding are recommended.	1.0mm ²
16	CAN_L		1.0mm ²
17	CAN_SCR		1.0mm ²
18	RS485_B	A 120 Ω shielded wire and good grounding are recommended.	1.0mm ²
19	RS485_A		1.0mm ²
20	RS485_SCR		1.0mm ²
21	Aux. Input 1	The grounding is valid according to the function selection switch input.	1.0mm ²
22	Aux. Input 2		1.0mm ²
23	Aux. Input 3		1.0mm ²
24	Aux. Input 4		1.0mm ²
25	Generator Voltage U	Connected to the power generation output R phase.	1.0mm ²
26	Generator Voltage V	Connected to the power generation output S phase.	1.0mm ²
27	Generator Voltage W	Connected to the power generation output T phase.	1.0mm ²
28	Generator Voltage N2	Connected to the power generation output N phase.	1.0mm ²
29	Mains Voltage R	Connected to the mains U phase.	1.0mm ²
30	Mains Voltage S	Connected to the mains V phase.	1.0mm ²
31	Mains Voltage T	Connected to the mains W phase.	1.0mm ²
32	Mains Voltage N1	Connected to the mains N phase.	1.0mm ²
33	Load CT Secondary L1	Current Transformer Secondary Rated	1.5mm ²

34	Load CT Secondary L2	5A/50mA.	1.5mm ²
35	Load CT Secondary L3		1.5mm ²
36	Load CT Secondary ICOM	Connect to the common.	1.5mm ²

◆ **DC40S 3-phase 4-wire Typical Wiring Diagram**

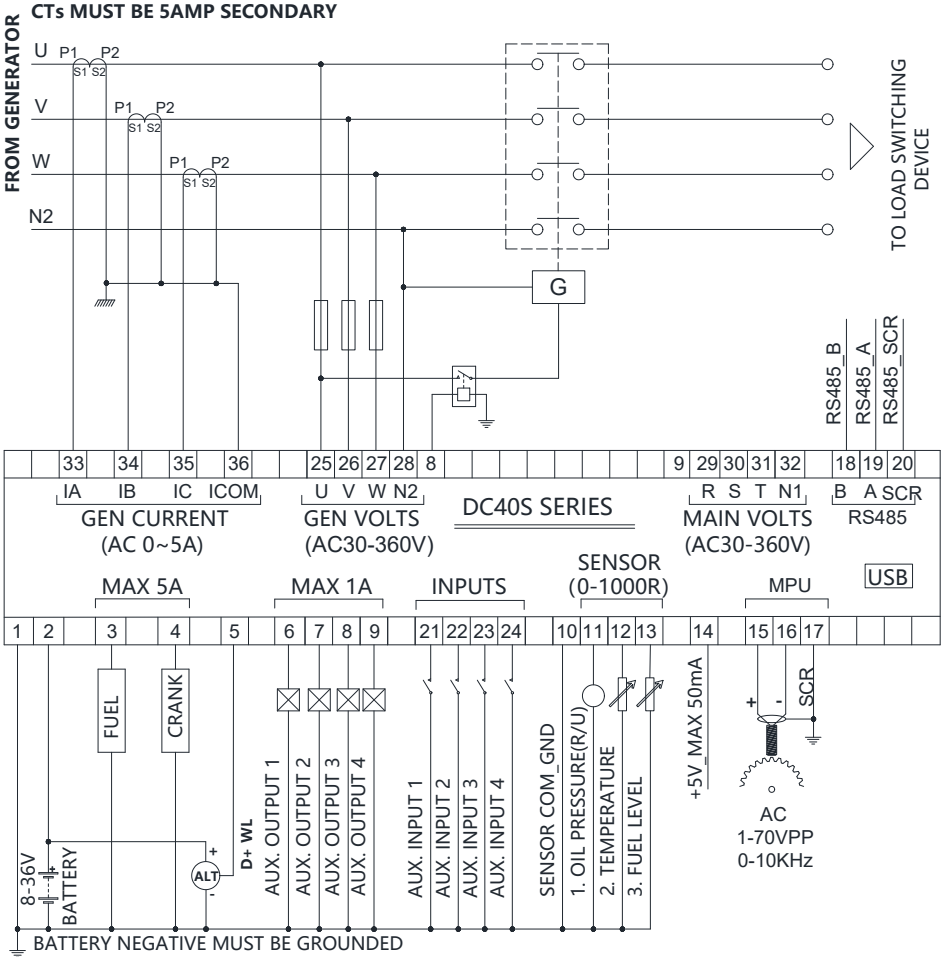

REMARK: 1.No. 10 common sensor lines must be securely attached to the vicinity of the sensor body.
2.To ensure reliable operation of the module and the measuring accuracy, power lines as much as possible and do not share power cable crude and other devices.



The charging coil can only be connected to pin 15 ,the speed sensor is connected to pins 15, 16 or 15, 17.



Note: Please don't move battery during running status or it may cause the controller broken!

◆ **DC42S 3-phase 4-wire Typical Wiring Diagram**

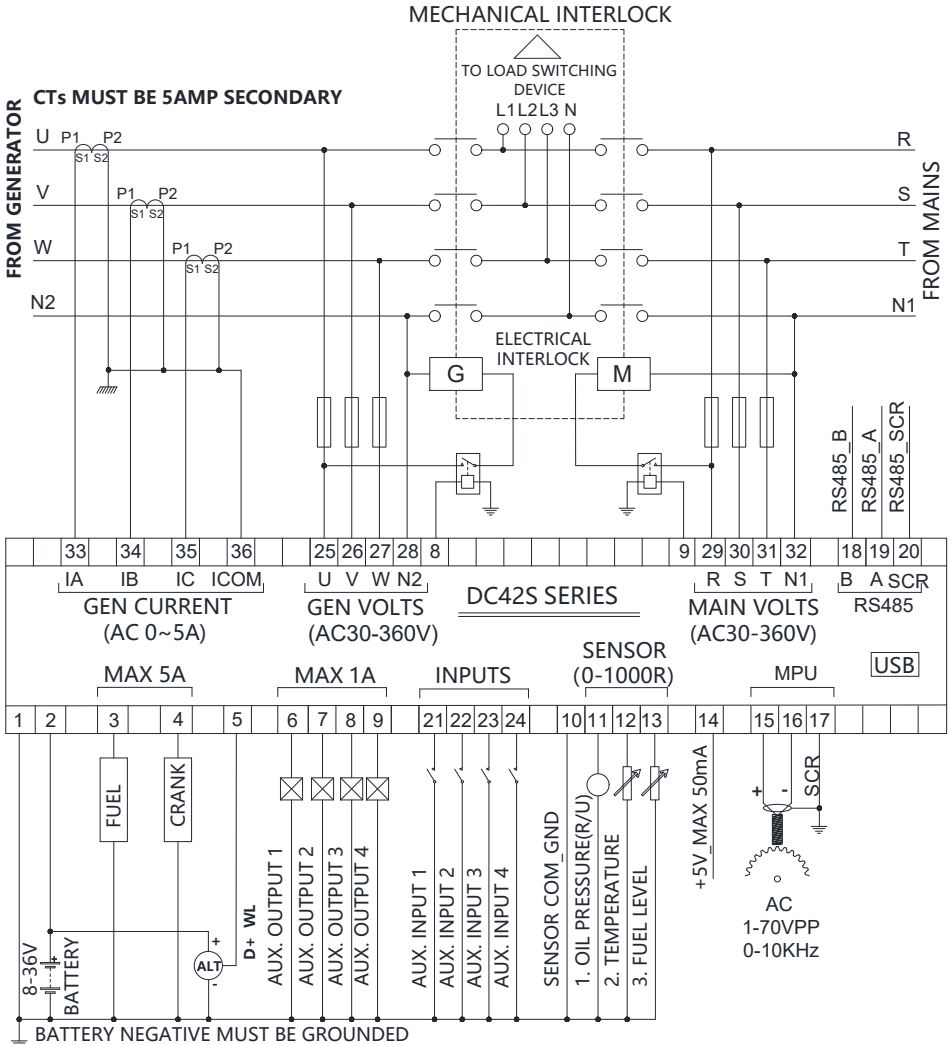

REMARK: 1.No. 10 common sensor lines must be securely attached to the vicinity of the sensor body
 2.To ensure reliable operation of the module and the measuring accuracy, power lines as much as possible and do not share power cable crude and other devices



The charging coil can only be connected to pin 15, the speed sensor is connected to pins 15, 16 or 15, 17.



Note: Please don't move battery during running status or it may cause the controller broken!

◆ **DC40C 3-phase 4-wire Typical Wiring Diagram**

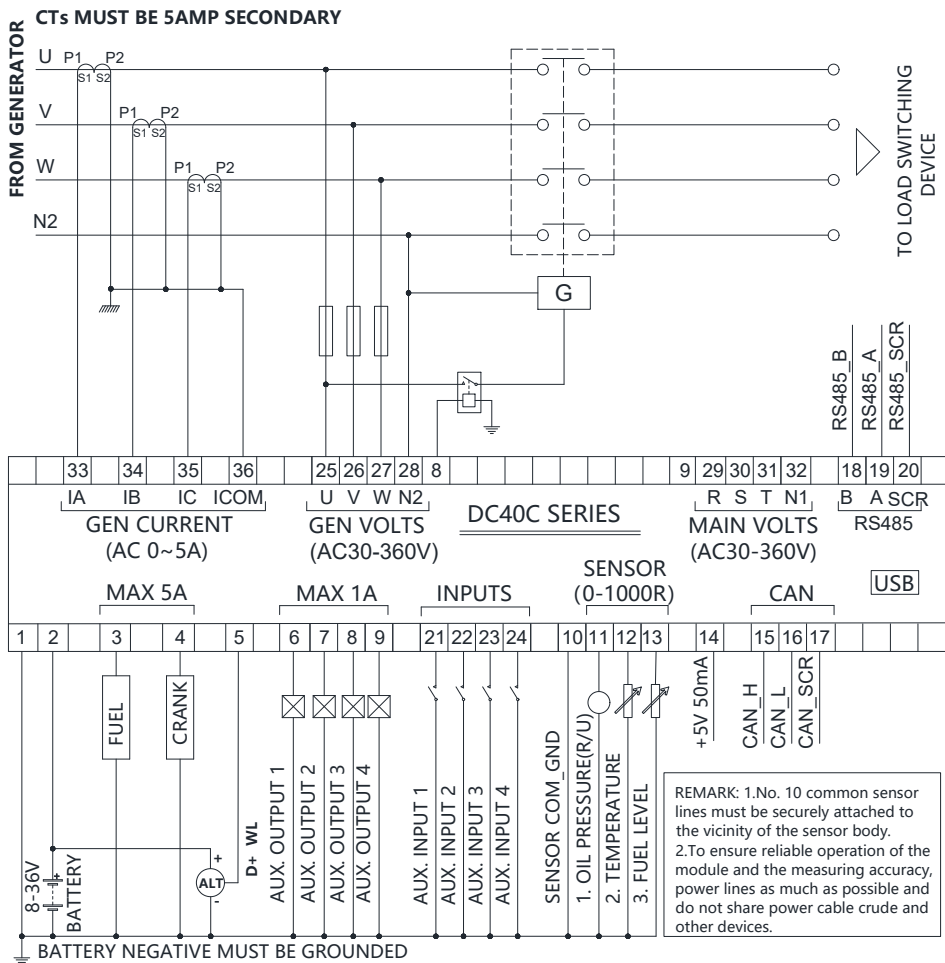

⚠ Note: Please don't move battery during running status or it may cause the controller broken!

⚠ WARNING: When generator is on-load, C. T. secondary must not be open circuit, Otherwise, the high voltage generated will pose a danger to personal safety.

◆ DC42C 3-phase 4-wire Typical Wiring Diagram

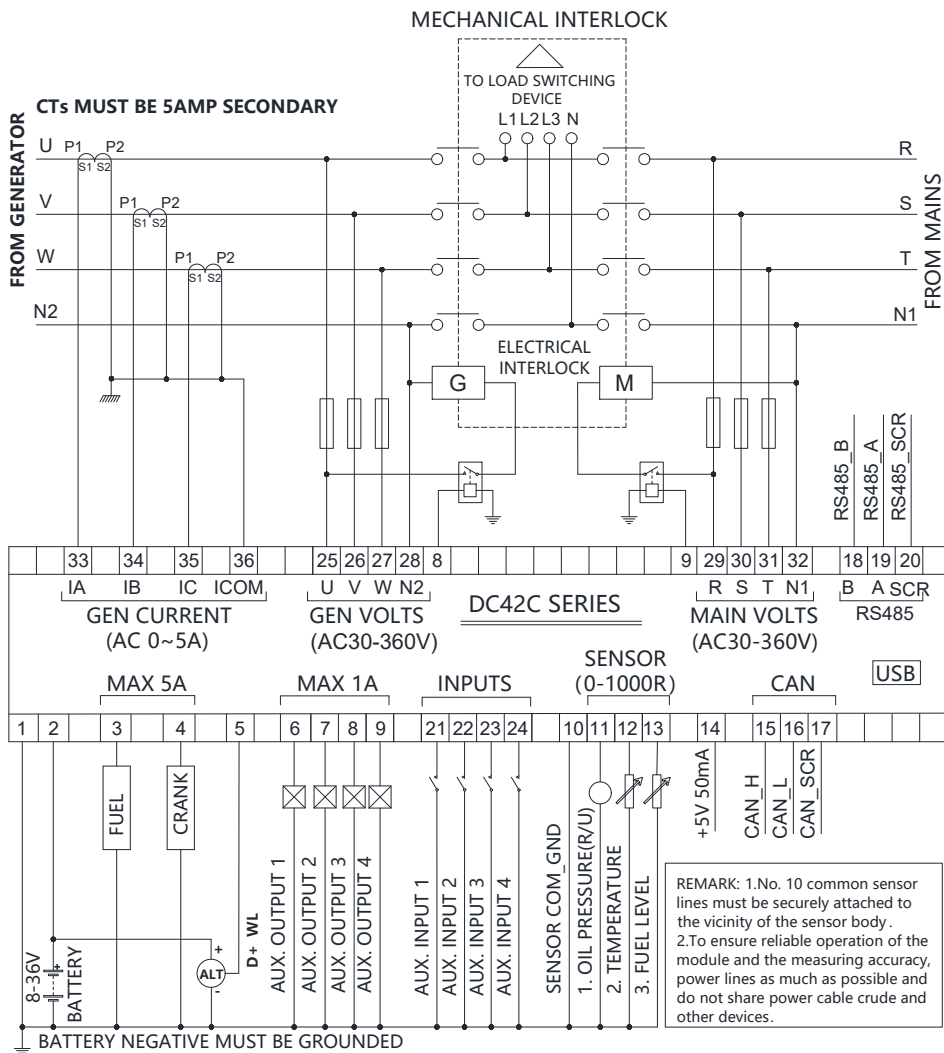

⚠ Note: Please don't move battery during running status or it may cause the controller broken!

⚠ WARNING: When generator is on-load, C. T. secondary must not be open circuit, Otherwise, the high voltage generated will pose a danger to personal safety.

◆ DC42ST 3-phase 4-wire Typical Wiring Diagram

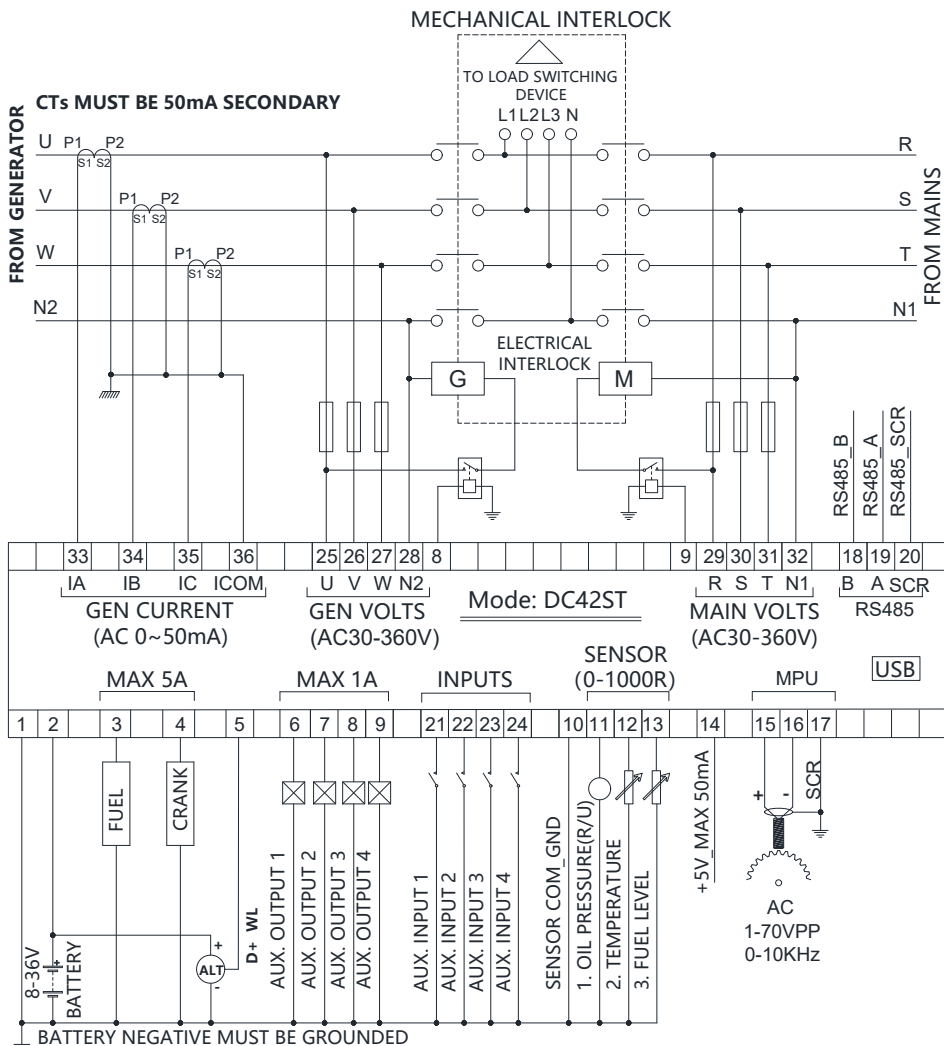

REMARK: 1.No. 10 common sensor lines must be securely attached to the vicinity of the sensor body.
2.To ensure reliable operation of the module and the measuring accuracy, power lines as much as possible and do not share power cable crude and other devices.

⚠ The charging coil can only be connected to pin 15 ,the speed MPU is connected to pins 15, 16 or 15, 17.

⚠ Note: Please don't move battery during running status or it may cause the controller broken!

◆ **DC40 Series 1-phase 2-wire Typical Wiring Diagram**

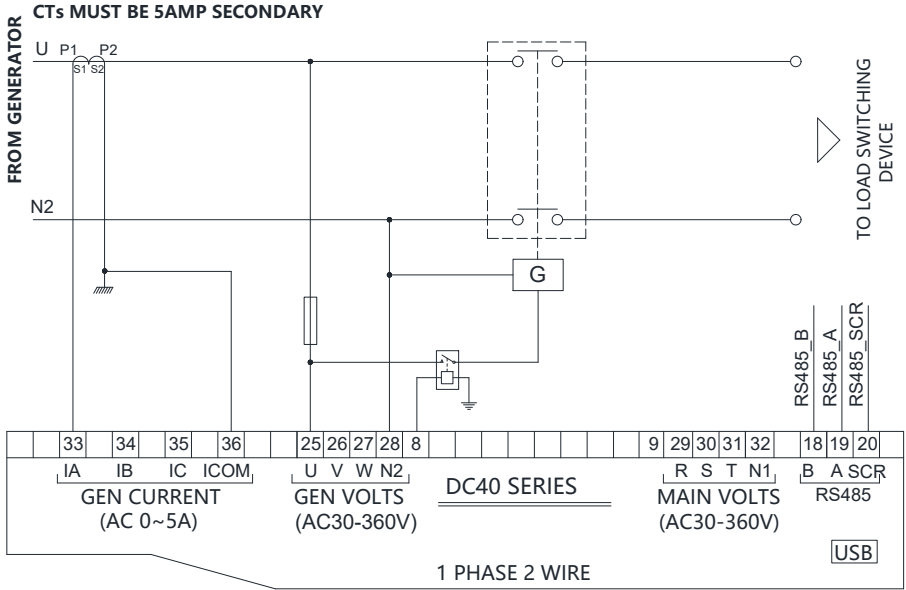

◆ **DC42 Series 1-phase 2-wire Typical Wiring Diagram**

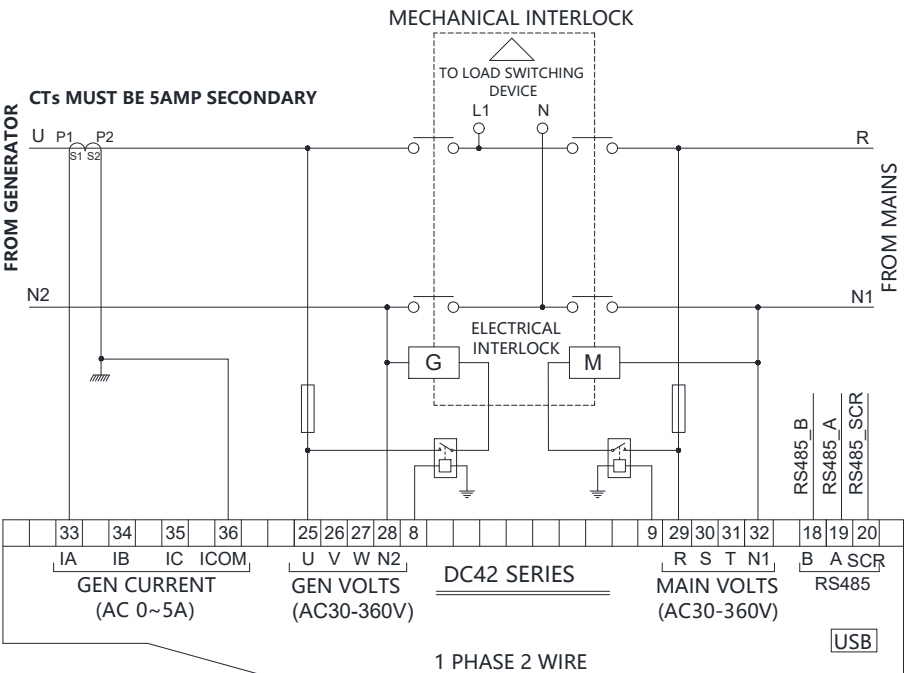

◆ **DC40 Series 2-phase 3-wire Typical Wiring Diagram**

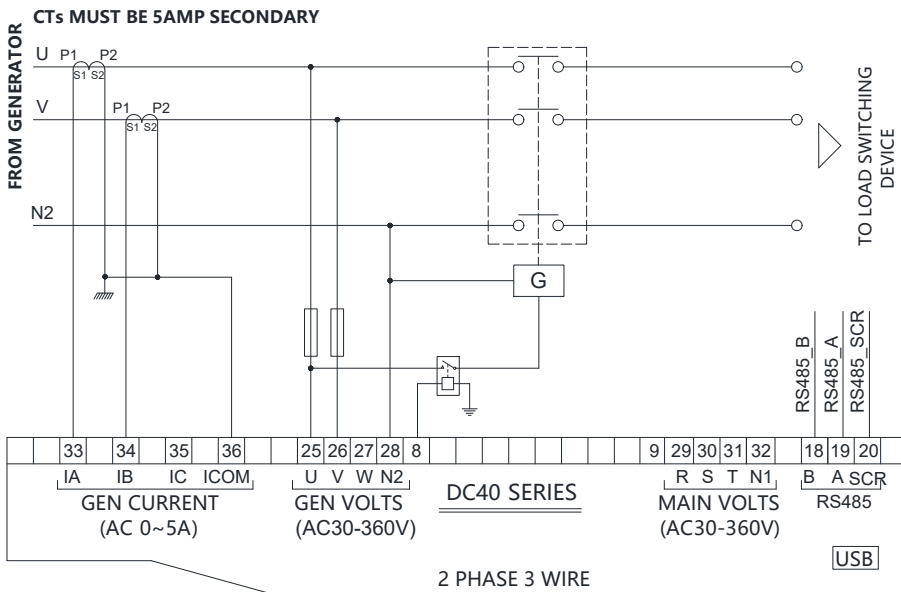

◆ **DC42 Series 2-phase 3-wire Typical Wiring Diagram**

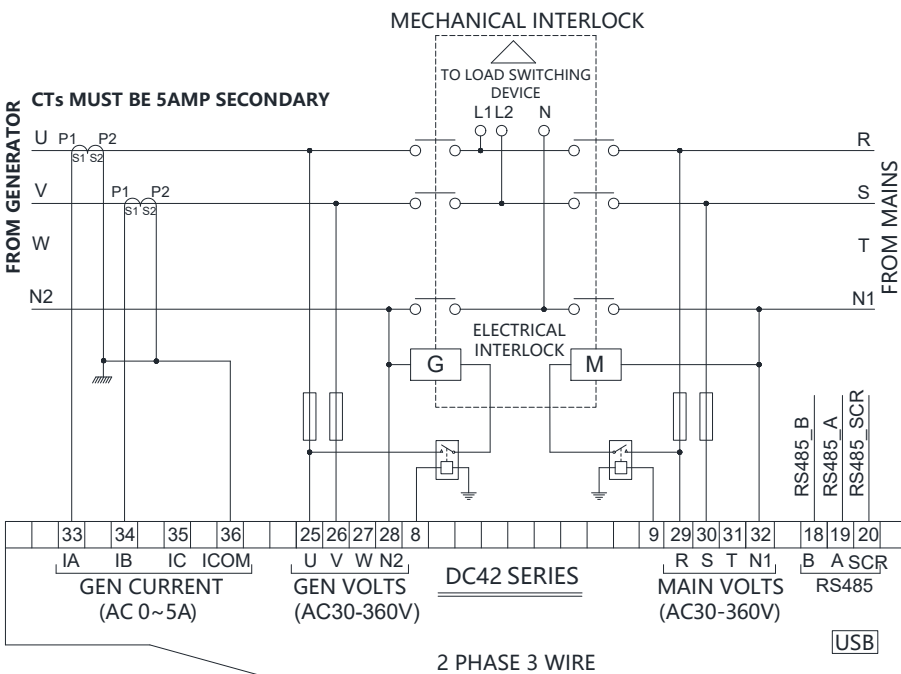

7. Installation instruction

- ◆ The controller is fixed by two special fixing members and screws, and the screws of the metal fasteners cannot be too tight.
- ◆ Panel Cutout: W1160mm*H90mm.

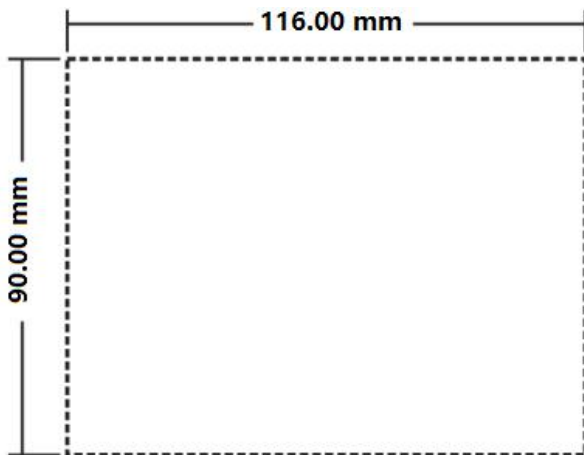

Note: If the controller is installed directly in the genset shell or other fluctuated equipment, the rubber pad must be installed.

◆ Battery Voltage Input

DC4xS/C controller is suitable for 8-36V DC battery voltage. Battery negative must be reliably connected to the enclosure of the engine. The controller power supply B+ and B- must be connected to battery positive and negative, and the wire size must not be less than 2.5mm².

NOTE:

In case of floating charger connect charger output to battery positive and negative directly, then, connect battery positive and negative poles to controller positive and negative power supply.

◆ Output and relay expansion

Note: All outputs of the controller are relay contacts. The maximum current capacity is described in the "Parameters" in this manual. Please use it in the relay current capacity. If an extended relay is needed, add a continuous current diode (when the extended relay coil is DC) or a resistance-capacitance loop (when the extended relay coil is AC) to both ends of the coil to prevent interference with the controller or other equipment.

◆ AC current input

Current transformer with rated secondary current 5A must be externally connected to the controller current input.

WARNING: When generator is on-load, C. T. secondary must not be open circuit, Otherwise, the high voltage generated will pose a danger to personal safety.

◆ **Withstanding voltage test**

⚠ If withstanding voltage test is conducted after the controller has already been installed onto the control panel, please unplug all controller terminal connections in order to prevent high voltage from damaging it.

8. Panel and display

◆ **DC40S/C**

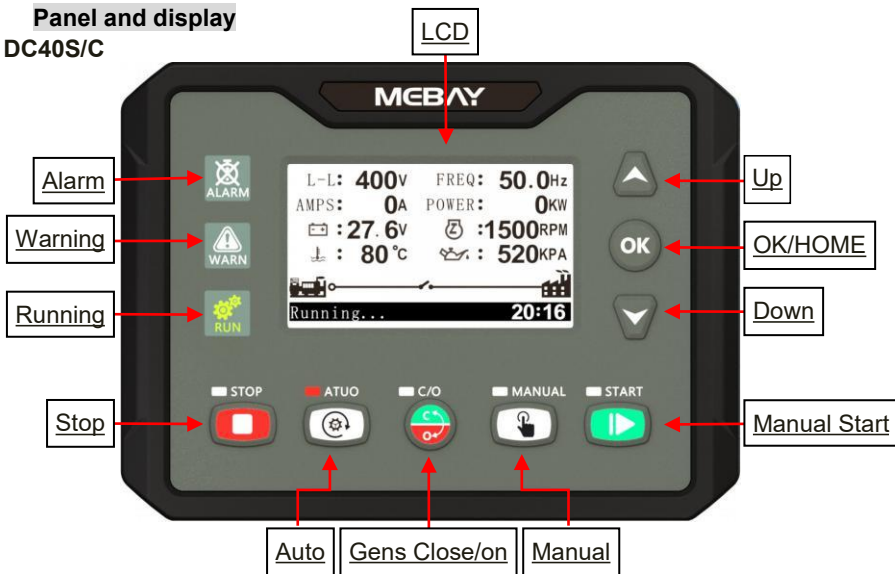

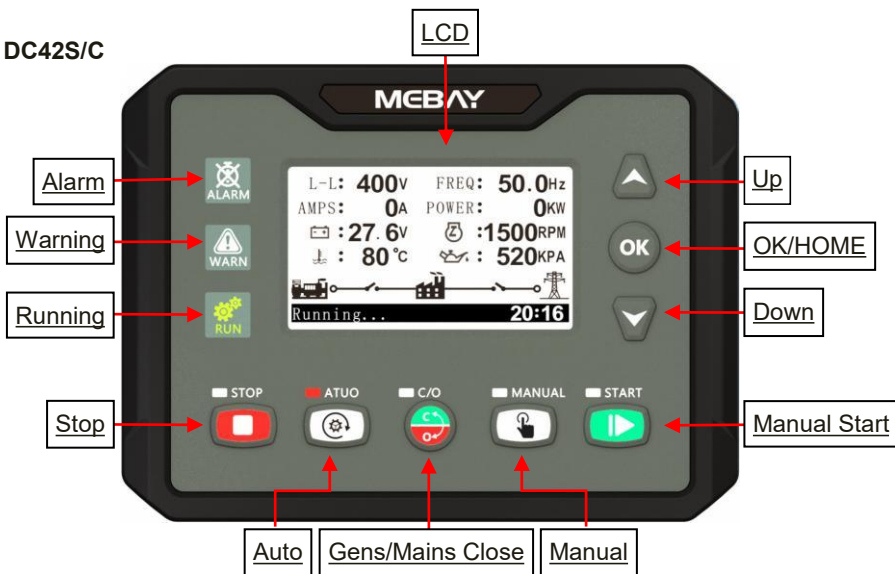

◆ **DC42S/C**



◆ Key Function Description









KEYS	NAME	Main Function
	Stop Reset Revert	<ul style="list-style-type: none"> ◆ Can stop generator under manual/auto mode; ◆ Can reset shutdown alarm ◆ During stop procession, pressing this key again can stop generator immediately. ◆ Pressing this key can cancel the setting and back to upper class under edition. ◆ Under the setting mode with checking data, the data can be saved and system will exit after pressing. ◆ In the standby state of the stop gear without any alarm, press this key for 3 seconds to view the alarm record.
	Start	<ul style="list-style-type: none"> ◆ Start the genset under manual mode. ◆ Pressing this key can start the genset under manual testing mode. ◆ In the stop gear, press this key, the oil valve and ECU power supply will output;(Only DC4xC series has)
	Manual	<ul style="list-style-type: none"> ◆ Pressing this key will set the module into manual mode.
	Auto	<ul style="list-style-type: none"> ◆ Pressing this key will set the module into auto mode.
	Gens/ Mains Close/On	<ul style="list-style-type: none"> ◆ Under manual mode, pressing this key can transfer load to genset/mains. ◆ Press this key for 3 seconds,public unload of Gens and Mains.
	Up	<ul style="list-style-type: none"> ◆ Under display mode, parts of the page can move up. ◆ Under edition mode, pressing this key to move the digit or increase the numbers. ◆ Under records mode, pressing this key to move the digit.
	Down	<ul style="list-style-type: none"> ◆ Under display mode, parts of the page can move down. ◆ Under edition mode, pressing this key to move the digit or decrease the numbers. ◆ Under records mode, pressing this key to move the digit.
	OK UI Change	<ul style="list-style-type: none"> ◆ Confirm the change under edition mode. ◆ Shift right under edition mode. ◆ Page exited under records checking mode. ◆ Black UI and white UI can be switched when Pressing. ◆ In standby state, press for 3 seconds to enter the parameter setting mode.
	LED Test	<ul style="list-style-type: none"> ◆ Test if all LED lights are OK, pressing this key to test if all lighted, all off when loosen it.
	Setting mode	<ul style="list-style-type: none"> ◆ Pressing OK and STOP simultaneously to come into setting mode

◆ Engine flywheel teeth automatic adjustment

- 1) Crank disconnect must be set to include both "speed" and "frequency" options.
- 2) When the generator frequency and engine speed are not zero, press  and  for more than 0.5 seconds, the controller will automatically calculate and save the number of flywheel teeth according to the generation frequency and generator poles.
- 3) After calculating and saving the number of flywheel teeth successfully, the controller shows: "**Flywheel xxx teeth, saved successfully!**"

◆ Alarm records checking





DC4xS/C controller can save **100** groups of alarm records which contains time, gens parameter, engine parameter and so on. How to check the alarm records:



- 1) Enter alarm record page:
 - a) Under stop mode, press this  key for 3 seconds come into alarm records page;
 - b) Enter the setting mode: Select the alarm record and press  key to alarm records page;
- 2) Press  to turn upper digit and press  to turn lower digit in order to choose the record you need. Press  to confirm the record and come into history records checking page.
- 3) Press  to turn lower records under records checking page. Press  to turn upper records and press  to revert back to alarm history records page.
- 4) Exit from records page: In the history records page and checking page, press  to exit;

◆ View controller system log



DC4xS/C series generator set controller can save 5000 system logs, including operation time, generator set startup, key operation, parameter modification, controller power on and other records.

The steps to view the system log are as follows:

- 1) Press the key  for more than 3 seconds. Or press the stop key  without releasing, press the OK key  again, and then release all the keys to enter the setting menu page;
- 2) In the setting menu page, select "**System logs**" and press the OK key  to enter the password input page;
- 3) Enter the controller parameter setting password, and the default factory password is "**07623**"; after entering the password, press the OK key  once to enter the system log page;

4) In the system log page, press the up key  and down key  to browse the operation log, and the latest operation is recorded in the front; press the STOP key  to exit the system log page.



◆ **Emergency start mode:**

In manual mode, pressing the "MANUAL" button  and the "START" button  at the same time can force the generator to start. At this time, the controller will no longer automatically judge the successful start condition, and the operator will judge the separation of the starter by himself. The operator observes that the unit has started successfully. After releasing the "START" button , the starter motor will be disconnected immediately, and the controller will enter the "safety protection delay" state.

9. Control and operation instruction

Manual Start Mode

press  and make sure it is in the stop position before starting.

Press "MANUAL"  and the test file indicator is on. At this time, it is detected whether the connection of each sensor is normal. If the sensor is open, the sensor opens an alarm. If it is normal, the unit start process is executed in the following sequence after pressing the "START" . automatically switch to Generator provide the power when the unit is running normally. Press "STOP"  The controller performs the parking process at the following timing:

Manual start and stop process:

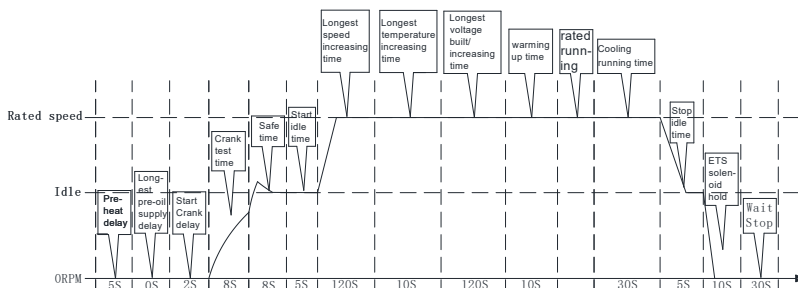

After the manual start is successful, pressing the "automatic key"  can be converted into an automatic file. The specific working time is as follows:

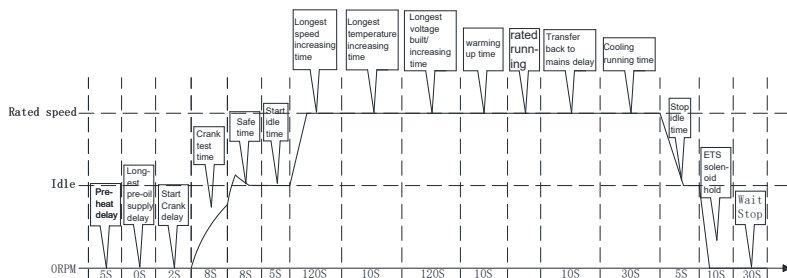

Automatic starting mode:

press and make sure it is in the stop position before starting.

Press “” and the test file indicator is on. At this time, it is detected whether the connection of each sensor is normal. If the sensor is open, the sensor opens an alarm. If it is normal, wait for the remote start signal to be valid (DC42 series detected the remote starting signal is valid or the mains provide the power is invalid). The unit will perform the starting process in the following sequence. When the unit enters the normal rated operation, it will automatically switch to the generator provide the power. The controller will detect the remote start signal and the mains status in real time (DC42 series is available). When the remote start signal fails and the mains provide the power returns to normal, the shutdown process after the "loop time delay" is performed (DC42 series is available).

Auto start and stop process:

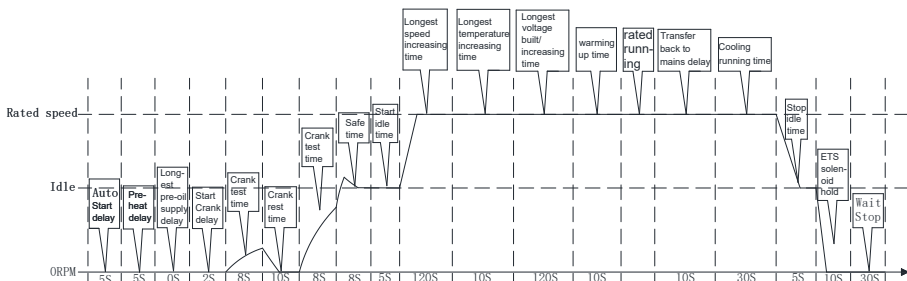

◆ Notices in Starting Process



Note 1: During the Cranking time, the controller automatically detects the speed signal, frequency signal and oil pressure value or the charging voltage (according to the parameter setting) to reach the judgment condition of successful start, then the judgment is that the start is successful and the motor relay is closed.



Note 2: Within the safety delay, only respond to emergency stop, immediate stop, over speed, over frequency, Over voltage, ECU communication Failure, shutter open abnormal, other alarms are not responded to.



Note 3: No response to alarm and warning of under speed, low frequency, under voltage, over current, over power, non-balance of current, external instant

unloading shutdown,during start idle time.



Note 4: No response to low frequency, under voltage, over current non-balance of current,external instant unloading shutdown and over power is required when entering the RPM-up time.



Note 5: No response to low frequency, under voltage, over current non-balance of current,external instant unloading shutdown and over power is required when entering the temperature-up time.



Note 6: No response to low frequency, under voltage, over current non-balance of current,external instant unloading shutdown and over power is required when entering the Voltage-up time.



Note 7: No response to low frequency, under voltage, over current non-balance of current,external instant unloading shutdown and over power is required when entering the Warming-up time.



Note 8: After entering rated operation, the Gens load relay output.



Note 9: In the process of shutdown, if the remote starting signal is restored to be valid within the " Cooling time", the rated operation will be entered again.



Note 10: If the stop key is pressed again during idle time, the idle time will be canceled and the stop operation will be executed directly.

10. Warnings and Shutdown Alarms

◆ Warnings



Notes: Warning is a non-serious failure state, which will not harm the gensets system for the time being. It only reminds operators to pay attention to the situation that does not meet the requirements and solve it in time to ensure the continuous operation of the system. When the warning occurs, the gensets does not stop. Once the fault is removed, the warning is automatically canceled.

Low Oil Pressure Sensor Warning

When the controller parameter "**Action if low oil pressure**" is set to "**Warning**" and the AUX. input port "**Low oil pressure shutdown disabled**" switch is valid,and the controller detects that the engine Oil Pressure is lower than "**Low oil pressure warning**", Then start warning delay and the duration (Normal alarm delay) have not returned to normal, the warning of low Oil Pressure is reported. "**WARNING**" lights will light up, Generators will not stop, displays "**Low OP sensor**" on the current fault screen.

Low Oil switch Warning

When the controller parameter "**Action if low oil pressure**" is set to "**Warning**" and the AUX. input port "**Low oil pressure shutdown disabled**" switch is valid,and the

controller detects that the engine Oil Pressure is lower than "**Low oil pressure warning**", Then start warning delay and the duration (Normal alarm delay) have not returned to normal, the warning of low Oil Pressure is reported. "**WARNING**" lights will light up, Generators will not stop, displays "**Low OP Switch**" on the current fault screen.

High temperature sensor warning

When the controller parameter "**Action if high temperature**" is set to "**Warning**" and the AUX. input port "**High temperature disabled**" switch is valid, and the controller detects that the coolant temperature value is higher than the "**High temperature warning**", Then start warning delay and the duration (Normal alarm delay) have not returned to normal, the warning of High coolant temperature warning is reported. "**WARNING**" lights will light up, Generators will not stop, displays "**High WT sensor**" on the current fault screen.

High temperature switch warning

When the controller parameter "**Action if high temperature**" is set to "**Warning**" and the AUX. input port "**High temperature disabled**" switch is valid, and the controller detects that the coolant temperature value is higher than the "**High temperature warning**", Then start warning delay and the duration (Normal alarm delay) have not returned to normal, the warning of High coolant temperature warning is reported. "**WARNING**" lights will light up, Generators will not stop, displays "**High WT sensor**" on the current fault screen.

Low fuel level sensor warning

When the controller detects that the fuel level value is lower than the "**Low fuel level warning**", Then start warning delay and the duration (Normal alarm delay) have not returned to normal, the warning of Low fuel level warning is reported. "**WARNING**" lights will light up, Generators will not stop, displays "**Low fuel level-A**" on the current fault screen.

Low fuel level switch warning

When the controller detects that the AUX. input "**Low fuel level warning input**" switch is active, it starts warning delay and lasts for Normal alarm delay. When the "**Low fuel level warning input**" switch is enabled, the engine low fuel level switch warning is reported. "**WARNING**" lights will light up, Generators will not stop, displays "**Low fuel level-D**" on the current fault screen.

External instant warning

When the controller detects that the AUX. input "**External instant warning input**" switch is active, it starts warning delay and lasts for Normal alarm delay. When the "**External instant warning input**" switch is enabled, the warning is reported. "**WARNING**" lights will light up, Generators will not stop, displays "**Instant warn**" on the current fault screen.

Speed signal lost warning

When the controller parameter "**Action if RPM lost**" is set to "**warning**", the detected speed value is 0, Then start warning delay and the duration (Normal alarm delay) have not returned to normal, the warning of speed signal lost warning is reported. "**WARNING**" lights will light up, Generators will not stop, displays "**Lose speed**" on

the current fault screen.

Oil pressure sensor disconnected warning

When the controller parameter "**Action if low oil pressure sensor disconnected**" is set to "**warning**", When the oil pressure sensor is detected to be disconnected, Then start warning delay and the duration (Normal alarm delay) have not returned to normal, the warning of Oil pressure sensor disconnected warning is reported. "**WARNING**" lights will light up, Generators will not stop, displays "**OP sensor open**" on the current fault screen.

Coolant temperature sensor disconnected warning

When the controller parameter "**Action if water temperature sensor disconnected**" is set to "**warning**", When the coolant temperature sensor is detected to be disconnected, Then start warning delay and the duration (Normal alarm delay) have not returned to normal, the warning of coolant temperature sensor disconnected warning is reported. "**WARNING**" lights will light up, Generators will not stop, displays "**WT sensor open**" on the current fault screen.

Over battery voltage warning

When the controller detects that the battery voltage is higher than the "**Over battery voltage warning**", Then start warning delay and the duration (Normal alarm delay) have not returned to normal, the warning of Over battery voltage warning is reported. "**WARNING**" lights will light up, Generators will not stop, displays "**Over voltage**" on the current fault screen.

External instant unloading switch warning

When the controller detects that the AUX. input "**External instant unloading shutdown disabled**" switch is active, it starts warning delay and lasts for Normal alarm delay. When the "**External instant unloading shutdown disabled**" switch is enabled, the warning is reported. "**WARNING**" lights will light up, Generators will not stop, displays "**Unload switch**" on the current fault screen.

Fuel Level sensor disconnected warning

When the controller parameter "**Action if fuel Level sensor disconnected**" is set to "**warning**", When the fuel Level sensor is detected to be disconnected, Then start warning delay and the duration (Normal alarm delay) have not returned to normal, the warning of fuel Level sensor disconnected warning is reported. "**WARNING**" lights will light up, Generators will not stop, displays "**FL sensor open**" on the current fault screen.

Maintenance expiration warning

When the controller parameter "**Maintenance expire**" is set to "**warning**", when the primary countdown to maintenance is detected as "0" or primary maintenance date less than current date, then start warning delay and the duration (normal alarm delay), the warning of maintenance expiration is reported. "**WARNING**" lights on, without stopping the engine, and displays "**Maintain end**" on the LCD screen.

Low coolant level switch warning

When the controller detects that the AUX. input "**Low water level warning**" switch is active, it starts warning delay and lasts for Normal alarm delay. When the "**Low**

water level warning" switch is enabled, the engine low coolant level switch warning is reported. **"WARNING"** lights will light up, Generators will not stop, displays **"Low water level"** on the current fault screen.

Over battery voltage warning

When the controller detects that the battery voltage is over than the **"Over battery voltage warning"**, Then start warning delay and the duration (Normal alarm delay) have not returned to normal, the warning of over battery voltage warning is reported. **"WARNING"** lights will light up, Generators will not stop, displays **"Over BATT volt"** on the current fault screen.

Under battery voltage warning

When the controller detects that the battery voltage is lower than the **"Under battery voltage warning"**, Then start warning delay and the duration (Normal alarm delay) have not returned to normal, the warning of Under battery voltage warning is reported. **"WARNING"** lights will light up, Generators will not stop, displays **"Under BATT volt"** on the current fault screen.

Charging failure warning

When the gap between D+ and B+ is over than this value, and there is charging failure but still high(normal warning delay), then charge failure warns. **"WARNING"** lights will light up, Generators will not stop, displays **"Charger fault"** on the current fault screen. Once the gap is lower than the value, warns clear.

ECU faults warning

When the controller detects the warning information of ECU, Then start warning delay and the duration (Normal alarm delay) have not returned to normal, the warning of ECU faults warning is reported. **"WARNING"** lights will light up, Generators will not stop, displays **"ECU faults warn"** on the current fault screen.

ECU Communication Failure Warning

When the controller parameter **"CAN failure"** is set to **"warning"**, and controller does not receive any message sent by ECU. It started to delay and lasted for some time (Normal alarm delay) but still did not receive the message from ECU, the warning of ECU faults warning is reported. **"WARNING"** lights will light up, Generators will not stop, displays **"ECU comm. fail"** on the current fault screen.

◆ Starting fault

Fail to Start

If the number of cranks exceeds the predetermined number of cranks, the failure of start-up will be reported if the start-up of the generating unit is still unsuccessful. **"ALARM"** lights on, without stopping the engine, and displays **"Crank failure "** on the current fault screen.

◆ Shutdown Alarms



Warning: After the Shutdown Alarm occurs, the system will be locked immediately and the generator set will be stopped. Only after troubleshooting, press



key to clear the alarm, can it be re-operated.



Notes: When the shutdown alarm failure occurs, the "**ALARM**" lights will light up and the generator unit automatically stops.

Over speed alarm

When the controller detects that the engine speed is higher than "**Over speed alarm**", Then start alarm delay and the duration (Emergency delay) have not returned to normal, the alarm of over speed is reported. "**ALARM**" lights flicker, Generator stops running, and displays "**Over speed**" on the current fault screen.

Under speed alarm

When the controller detects that the engine speed is under than "**Under speed alarm**", Then start alarm delay and the duration (Normal alarm delay) have not returned to normal, the alarm of under speed is reported. "**ALARM**" lights flicker, Generator stops running, and displays "**Under speed**" on the current fault screen.

Low oil pressure sensor alarm

When the controller detects that the engine Oil Pressure is lower than "**Low oil pressure alarm**", Then start alarm delay and the duration (Normal alarm delay) have not returned to normal, the alarm of low Oil Pressure is reported. "**ALARM**" lights flicker, Generator stops running, and displays "**Low OP sensor**" on the current fault screen.

Low oil pressure switch alarm

When the controller detects that the AUX. input port "**Low oil pressure alarm input**" switch is active. Start low oil pressure switch alarm delay, for a period of time "general alarm delay" AUX. input port "low oil pressure alarm input" switch is valid. Then the alarm, the public alarm light "**ALARM**" light is always on, stop the unit operation, and display "**Low OP switch**" on the current fault screen.

High temperature sensor alarm

When the controller detects that the temperature value is higher than the "**High temperature alarm**", Then start alarm delay and the duration (Normal alarm delay) have not returned to normal, the alarm of High temperature alarm is reported. "**ALARM**" lights will light up, Generator stops running, and displays "**High Temp sensor**" on the current fault screen.

High Temperature Switch Alarm

When the controller detects that the High temperature alarm switch input is valid to the ground, then start alarm delay and the duration (Normal alarm delay) have not returned to normal, the alarm of High Temperature Switch is reported. "**ALARM**" lights flicker, Generator stops running, and displays "**High Temp switch**" on the current fault screen.

Low fuel level sensor alarm

When the controller detects that the fuel level value is lower than the "**Low fuel level alarm**", Then start alarm delay and the duration (Normal alarm delay) have not

returned to normal, the alarm of Low fuel level alarm is reported. **"ALARM"** lights will light up, Generator stops running, and displays **"Low fuel level-A"** on the current fault screen.

Low fuel level switch alarm

When the controller detects that the AUX. input **"Low fuel level alarm input"** switch is active, it starts alarm delay and lasts for Normal alarm delay. When the **"Low fuel level alarm input"** switch is enabled, the engine low fuel level switch alarm is reported. **"ALARM"** lights will light up, Generator stops running, and displays **"Low fuel level-D"** on the current fault screen.

External instant alarm

When the controller detects that the **"External instant alarm input"** switch of the AUX. input port is valid, the external instant trip is started and the shutdown alarm delay is delayed for a period of time **"Normal alarm delay"** AUX. input port **"External instant alarm input"** switch When it is valid, it will alarm, the public alarm light **"ALARM"** lights will light up, Generator stops running, and display **"Instant parking"** on the current fault screen.

Speed signal lost alarm

When the controller parameter **"Action if RPM lost"** is set to **"alarm"**, the detected speed value is 0, Then start alarm delay and the duration (Normal alarm delay) have not returned to normal, the alarm of speed signal lost warning is reported. **"ALARM"** lights will light up, Generator stops running, displays **"Lose speed"** on the current fault screen.

Oil pressure sensor disconnected alarm

When the controller parameter **"Action if low oil pressure sensor disconnected"** is set to **"alarm"**, When the oil pressure sensor is detected to be disconnected, Then start alarm delay and the duration (Normal alarm delay) have not returned to normal, the alarm of Oil pressure sensor disconnected alarm is reported. **"ALARM"** lights will light up, Generator stops running, displays **"OP sensor open"** on the current fault screen.

Temperature sensor disconnected alarm

When the controller parameter **"Action if temperature sensor disconnected"** is set to **"alarm"**, When the temperature sensor is detected to be disconnected, Then start alarm delay and the duration (Normal alarm delay) have not returned to normal, the alarm of temperature sensor disconnected alarm is reported. **"ALARM"** lights will light up, Generator stops running, displays **"Temp sensor open"** on the current fault screen.

Fuel Level sensor disconnected alarm

When the controller parameter **"Action if fuel Level sensor disconnected "** is set to **"alarm"**, When the fuel Level sensor is detected to be disconnected, Then start alarm delay and the duration (Normal alarm delay) have not returned to normal, the alarm of fuel Level sensor disconnected alarm is reported. **"ALARM"** lights will light up, Generator stops running, displays **"FL sensor open"** on the current fault screen.

Over frequency alarm

When the controller detects that the generator frequency is higher than “**Over frequency alarm**”, Then start alarm delay and the duration (Emergency delay) have not returned to normal, the alarm of over frequency is reported. “**ALARM**” lights will light up, Generator stops running, displays “ **Over frequency** ” on the current fault screen.

Under frequency alarm

When the controller detects that the generator frequency is lower than “**Under frequency alarm**”, Then start alarm delay and the duration (Normal alarm delay) have not returned to normal, the alarm of under frequency is reported. “**ALARM**” lights will light up, Generator stops running, displays “ **Under frequency** ” on the current fault screen.

Over voltage alarm

When the controller detects that the generator voltage is higher than “**Over voltage alarm**”, Then start alarm delay and the duration (Normal alarm delay) have not returned to normal, the alarm of over voltage is reported. “**ALARM**” lights will light up, Generator stops running, displays “ **Over voltage** ” on the current fault screen.

Under voltage alarm

When the controller detects that the generator voltage is lower than “**Under voltage alarm**”, Then start alarm delay and the duration (Normal alarm delay) have not returned to normal, the alarm of under voltage is reported. “**ALARM**” lights will light up, Generator stops running, displays “ **Under voltage** ” on the current fault screen.

Over current alarm

When the controller detects that the generator phase current is higher than “**Phase current over-load alarm**”, Then start alarm delay and the duration (Normal alarm delay) have not returned to normal, the alarm of over current is reported. “**ALARM**” lights will light up, Generator stops running, displays “ **Over current** ” on the current fault screen.

Over power alarm

When the controller detects that the generator power is higher than “**Over total power alarm**”, Then start alarm delay and the duration (Normal alarm delay) have not returned to normal, the alarm of over power is reported. “**ALARM**” lights will light up, Generator stops running, displays “ **Over power** ” on the current fault screen.

Non-balance current ratio alarm

When the controller is 2 phase 3 wire or 3 phase 4 wire, the controller detects that the unbalance degree of the three-phase or two-phase current of the generator is higher than the “**Non-balance current ratio alarm**”.Then start alarm delay and the duration (Normal alarm delay) have not returned to normal, the alarm of Non-balance current ratio is reported. “**ALARM**” lights will light up, Generator stops running, displays “ **Unbalance of AMP** ” on the current fault screen.

Maintenance Expiration Alarm

When the action after the primary maintenance expired set as "alarm", When the countdown to maintenance is detected as "0", Then start warning delay and the duration (Normal alarm delay) have not returned to normal, the warning of Maintenance expiration is reported. **"ALARM"** lights on, Generator stops running, and displays **"Maintain end"** on the current fault screen.

ECU faults alarm

When the controller detects the alarm information of ECU, Then start alarm delay and the duration (Normal alarm delay) have not returned to normal, the alarm of ECU faults alarm is reported. **"ALARM"** lights will light up, Generator stops running, displays **"ECU faults warn"** on the current fault screen.

ECU communication failure alarm

When the controller parameter **"CAN failure" is set to "alarm"**, and controller does not receive any message sent by ECU. It started to delay and lasted for some time (Normal alarm delay) but still did not receive the message from ECU, the alarm of ECU faults alarm is reported. **"ALARM"** lights will light up, Generator stops running, displays **"ECU comm. fail"** on the current fault screen.

Low coolant level switch alarm

When the controller detects that the AUX. input **"Low water level alarm"** switch is active, it starts alarm delay and lasts for Normal alarm delay. When the **"Low water level alarm"** switch is enabled, the engine low coolant level switch alarm is reported. **"ALARM"** lights will light up, Generator stops running, displays **"Low water level"** on the current fault screen.

Louver opening exception alarm

When the controller detects that the AUX. input **"Louver status input"** switch is active, it starts alarm delay and lasts for Normal alarm delay. When the **"Louver status input"** switch is enabled, the Louver status input alarm is reported. **"ALARM"** lights will light up, Generator stops running, displays **"Louver abnormal"** on the current fault screen.

Emergency stop alarm

When the controller detects that the input voltage of PIN 3 is less than 2V, then start alarm delay and the duration (Emergency delay) have not returned to normal, the alarm of Emergency Stop is reported. **"ALARM"** lights will light up, Generator stops running, and displays **"Emergency stop"** on the current fault screen.

Stop failure with frequency alarm

When the controller detects that the frequency is not "0" after the execution of the shutdown, the alarm of stop failure is reported. **"ALARM"** lights will light up and displays **"Stop fail-Hz"** on the current fault screen.

Stop failure with pressure alarm

When the controller detects that the Oil **Pressure** is not "0" after the execution of the shutdown, the alarm of stop failure is reported. **"ALARM"** lights will light up and displays **" Stop fail-OP-A "** on the current fault screen.



















Stop failure with oil pressure switch

When the controller detects that the oil pressure switch has not returned after the stop, it will alarm, the public alarm light “ALARM” lights will light up, and the current fault screen displays “ Stop fail-OP-D”.



11. Parameters setting

◆ Enter the edition page

Please set the parameters according to below steps:

- 1) The setting mode can be activated after pressing  and  simultaneously, under the status of standby without any alarm. The default password is “07623”.
- 2) Press  and add number 1, press  to reduce number 1, press  to turn the digit into right, press  once done. Then system comes into menu after confirmation of password setting. The screen will display error if password is wrong. The correct password should be put after pressing any button.
- 3) Press  to turn the digit into upper position, press  to turn the digit into lower position, press  to get into parameters setting page.
- 4) Press  to shift up the parameters, press  to shift down the parameters, press  to get into parameter changing page.
- 5) Press  to add number 1, press  to reduce number 1, press  to turn the digit into right, press  once done. If the parameters setting is in the valid setting range, then it can be saved, if not, it can not be saved.
- 6) Press  and  to save the parameters and exit from edition page.
- 7) Press  to revert back to last class if in any setting position.

 Revert back to default: put password “97011” when coming into parameters setting, then all the parameters can be set as defaults.

 Note: the data can't be saved if the user didn't press  and  to confirm the setting.

◆ Parameter setting

1) Delay time setting

No	Parameter	Range(default)	Notes
1	Start delay	0-65000s(5.0s)	The time during the genset starts after the remote signal is valid.
2	Preheat time	0-6500.0s (0.0s)	The time needed to be preheated before the starter on power.
3	Longest pre-oil supply	0-180.0s(0.0s)	Under pre-oil supply, if the oil pressure is higher than setting value, then pre-oil supply stopped.
4	Fuel output delay	1.0-60.0s (2.0s)	The time the fuel valve relay outputs before the motor operates.

5	Cranking time	3.0-60.0s (8.0s)	The time when the starter is on power.
6	Crank rest time	3.0-60.0s (10.0s)	If crank failure, the waiting time before the second test time.
7	Safety delay	1.0-60.0s (8.0s)	Low oil pressure, high water temperature, under speed, under frequency, under voltage, charge failure are all invalid during this time except for emergency stop and over speed.
8	Start idle time	0-3600.0s (5.0s)	Idle running time when crank successfully.
9	Longest RPM-up time	0-3600.0s (120.0s)	The longest speed-up time,during which time the system will exit once speed increased successfully .
10	Longest Temp.-up time	0-3600.0s (0.0s)	The longest warming-up time,during which time the system will exit once temperature increased successfully .
11	Longest Volt.-up time	0-3600.0s (120.0s)	The longest voltage-up time,during which time the system will exit once voltage increased successfully .
12	Warming-up time	0-3600.0s (10.0s)	The time needed for loading.
13	Cooling time	0-3600.0s (30.0s)	After unloading, the time of cooling down by radiator before stop. during the delay, if the remote start signal is valid, then genset will come into rated running.
14	Stop idle time	0-3600.0s (5.0s)	Idle-speed running time.
15	E.T.S. hold time	0-600.0s (10.0s)	Stop solenoid on power time.
16	Fail to stop	5-180.0s (30.0s)	If the RPM is 0 during the stop failure time, then the stop failure time is no needed.
17	Emergency delay	0-10.0s (1.5s)	Over speed and over frequency alarm delay.
18	Normal alarm delay	2.0-20.0s (5.0s)	The alarm delay except for over speed and over frequency.
19	Normal warning delay	1.0-20.0s (2.0s)	The warning delay.
20	Pulse speed up delay	0.1 – 60.0s (0.2s)	The interval time of the pulse speed up relay change.
21	Pulse speed down delay	0.1 – 60.0s (0.2s)	The interval time of the pulse speed down relay change.
22	Load pulse width	1.0-10.0s (5.0s)	Gens loading and unloading pulse width, when it is 10s, it is regarded as continuous output.
23	Unload pulse width	1.0-10.0s (3.0s)	
24	Transfer switch delay	0-3600.0s (1.0s)	The time from Mains to Gens.
25	AC Voltage abnormal delay	2.0-20.0s (10.0s)	Over / under voltage delay.
26	Back to Mains time	0-3600.0s (10.0s)	To avoid the switch actions if the mains unstable.If the remote start signal is invalid (DC42 series will check if the mains normal), genset will not switch immediately, after the delay time, it will transfer to

			mains. during the delay, if the remote start signal is valid, then genset will come into rated running.
27	Back to Gens time	0-3600.0s (5.0s)	There shall be loading delay from Mains to Gens if the remote start signal valid or Mains abnormal under Cooling time.

2)Engine setting

No	Parameter	Range (defaults)	Notes
1	CAN Protocol	0- Disabled 1: J1939 2: Cummins ISB 3: Cummins-CM850 4: Cummins QSX15-CM570 5: Cummins-CM850-PCC13X 6: Cummins-DCEC-QSZ13 7: Cummins-CCEC-QSN 8: Perkins 9: Perkins-1100 10: Volvo 11: Volvo-EMS2 12: Volvo-EMS2b 13: Volvo-EDC4 14: Scania 15: Scania-kw2000 16: Scania-kw2k-coo 17: John Deere 18: mtu-ADEC 19: mtu-ADEC-SAM 20: mtu-ADEC-303 21: mtu-ADEC-304 22: BOSCH 23: GTSC1 24: MTSC1 25: YUCHAI-YCECU 26: Y&C ENGINE-YC6K 27: WEICHAI-WISE15 28: CHANGCHAI-ECU15 29: YUCHAI-LMB 30: MAN 31: J1939-C 32: SDEC-H/D 33: SDEC-E 34: YTO 35: DEUTZ EMR2-2001 36: DEUTZ EMR2-2012 37: DEUTZ EMR3 38: DEUTZ EMR4 39: NEWND ECU13 40: Cummins-CM2150 41: Wuling CT4S010	CAN protocol Option: the Engine parameters like RPM, oil pressure, water temperature are all from ECU data after choosing the relative protocol.

		42:HSD-3M78	
2	Flywheel teeth	0-300 (0)	If the setting is 0, (RPM sensor Disabled), then RPM is resulted by Hz.
3	Rated RPM	500-4500RPM (1500)	Choose the meter range and calculate the alarm value.
4	Action if RPM lost	Warning Alarm and stop	This fault can be checked only if there is gens frequency checked as one condition of crank successfully.
5	RPM-up stop	0-200%(90%)	Rated RPM multiplying by this value is regarded as speed-up stop value. When the RPM is over this value, then the RPM-Up procession is stopped in time.
6	Overspeed alarm	0-200% (114%)	Rated RPM multiplying by this value is regarded as over speed alarm value. When the RPM is higher than the alarm value and comes into over speed delay but still higher (emergency faults delay), then over speed alarms. if the value is set as 200, then the over speed alarm is disabled.
7	Under speed alarm	0-200% (80%)	Rated RPM multiplying by this value is regarded as under speed alarm value. When the RPM is lower than the alarm value and comes into under speed delay but still lower (normal faults delay), then under speed alarms. if the value is set as 0, then the under speed alarm is disabled.
8	Battery Rated Voltage	8.0-36.0V (24.0V)	Standard for detecting of over/under voltage of battery.
9	Over battery voltage warning	0-200% (135%)	Rated battery voltage multiplying by this value is regarded as over battery voltage warning value. When the battery input is higher than the warning value and comes into over battery voltage delay but still higher (normal faults delay), then over battery voltage warns. if the value is set as 200, then the over battery voltage is disabled.
10	Under battery voltage warning	0-200% (67%)	Rated battery voltage multiplying by this value is regarded as under battery voltage warn value. When the battery input is lower than the warning value and comes into under battery voltage delay but still lower (normal faults delay), then under battery voltage warns. if the value is set as 0, then the under battery voltage is disabled.
11	Charger warning	1.0-30.0V (30.0V)	When the gap between D+ and B+ is over than this value, and there is charging

			failure but still high (normal warning delay), then charge failure warns. Once the gap is lower than the value, warns clear. If the value is set as 300, then the charge failure is disabled.
12	Manual crank times	1-30 (1 time)	Crank times under mode and test mode.
13	Auto start crank times	1-30 (3 times)	Crank times under auto mode.
14	E.T.S. hold times	1-10 (2 times)	The max E.T.S. hold on power shall be canceled once stop success under auto mode. the output interval time is " Fail to stop ".
15	Crank disconnect	RPM Frequency Oil pressure RPM/Frequency RPM/Oil Pressure Frequency/Oil Pressure RPM/Frequency/Oil press.	1.If there is no oil pressure sensor, please don't choose the type. 2.Oil pressure switch input is not the crank condition 3.Please check if the running status, stop condition are according with crank condition. 4.Means either of the conditions can be acceptable as crank condition. But all of them should be meet together to regard as stop condition.
16	Frequency disconnect	0-200% (28%)	Rated frequency multiplying by this value is regarded as crank success condition. When the gens frequency is over the condition value, then system regards it as crank success.
17	RPM disconnect	0-200% (24%)	Rated RPM multiplying by this value is regarded as crank success condition. When the RPM is over the condition value, then system regards it as crank success, motor escaped.
18	Oil pressure disconnect	0-400kpa (200kpa)	When the engine oil pressure is over the condition value, then system regards it as crank success, motor escaped.
19	Oil pressure delay	0-20.0s (0.0s)	When the crank condition contains oil pressure, if the oil pressure is higher than the presets value and continue for few seconds, then it is regarded as crank success.
20	OP pre-supply stop	50-600kpa(200kpa)	When the oil pressure is over the condition value, then pre-oil supply is stopped.
21	Fuel pump open	0-100% (25%)	When the fuel level is lower than preset value and remains 10S, fuel pump opened signal output
22	Fuel pump close	0-100% (80%)	When the fuel level is higher than preset value and remains 1S, fuel pump closed

			signal output.
23	Maximum fuel pump on time	0-65000s (65000s)	The maximum output time of the fuel pump.
24	Fuel pump filling detection	0-600s(30S)	Fuel pump filling detection time, the sensor oil level change is detected.
25	Temperature for Fan open	20-200℃ (75 ℃)	Used for controlling radiator: when the water temperature reaches the set temperature, then the radiator is opened.
26	Temperature for Fan close	20-200℃ (60 ℃)	Used for controlling radiator: when the water temperature is lower than the set temperature, then the radiator is closed.
27	Battery charging start	8.0-30.0 (25.6V)	When the battery voltage is lower than start value and remains 10s under non-running status, then the relay is opened.
28	Battery charging stop	10.0-36.0 (27.8V)	When it is higher than the close value and remains 10s, relay is closed. Once coming into running mode, there is no output.
29	Speed type	0-Speed sensor 1-Charging coil	Select the speed signal of different engine types.
30	RPM conversion	Disable Frequency to RPM	Whether the speed is converted from frequency.

3)Generator parameters

No	Parameter	Range(defaults)	Notes
1	Gens poles	2/4/6/8(4)	When the flywheel teeth are set as 0, the RPM will be resulted by frequency. Pole 2: 50Hz---3000RPM. Pole 4: 50Hz---1500RPM. Pole 6: 50Hz---1000RPM. Pole 8: 50Hz---750RPM
2	Gens AC system	Disable 1 phase 2 wire 2 phase 3 wire 3 phase 3 wire 3 phase 4 wire	Gens phases: No gens parameters can be displayed if setting as disable, which is applied to water pump genset.
3	Rated frequency	40.0-80.0Hz (50.0Hz)	Setting generator rated frequency to choose the meter range and calculate the alarm value.
4	Over freq alarm	0-200% (114%)	Rated frequency multiplying by this value is regarded as under over frequency alarm value. When the Freq is higher than the value and comes into over freq delay but still higher (emergency faults delay), then over frequency alarms, If the value is set as 200, then the alarm is disabled.
5	Under freq alarm	0-200% (80%)	Rated frequency multiplying by this value is regarded as under frequency alarm value. When the Freq is lower than the value and comes into under freq delay but still lower (normal faults delay), then under frequency alarms, If the value is set as 0, then the alarm is disabled.
6	Rated phase	80-420V(230V)	Setting generator phase voltage to choose the

	voltage		meter range and calculate the alarm value.
7	Voltage-up stop	0-200% (85%)	Rated voltage multiplying by this value is regarded as voltage-up stop value. When the voltage is over this value, then the voltage-Up procession is stopped in time.
8	Over voltage alarm	0-200% (120%)	Rated voltage multiplying by this value is regarded as over voltage alarm value. When the voltage is higher than the value and comes into over voltage delay but still higher (normal faults delay), then over voltage alarms, If the value is set as 200, then the alarm is disabled.
9	Under voltage alarm	0-200% (80%)	Rated voltage multiplying by this value is regarded as under voltage alarm value. When the voltage is lower than the value and comes into under voltage delay but still lower (normal faults delay), then under voltage alarms, If the value is set as 0, then the alarm is disabled.
10	ATS in manual mode	Disable/Enable	When it is set to enabled, when the generator set meets the closing conditions, it will be loaded automatically.

4>Loading setting

No	Parameter	Range (default)	Notes
1	CT rate	5-6000A (500A)	Used for setting genset CT primary current.
2	Rated phase current	5-6000A (500A)	Setting generator phase current to choose the meter range and calculate the alarm value.
3	Rated total power	5-2000Kw (276Kw)	Set total power of generator to choose the meter range and calculate the average loading rate and alarm value.
4	Phase current over-load alarm	0-200% (100%)	Rated current multiplying by this value is regarded as over current alarm value. When the current is higher than the value and comes into over current delay but still higher (over current faults delay), then over current alarms, If the value is set as 200, then the alarm is disabled.
5	Over phase current delay	0-3600.0s (30s)	When this parameter is set to 0, the over current delay is the inverse time; if not, the over current delay is the time set for this parameter.
6	Over current 【inverse time】	0.1-36.0 (36.0)	This option will not take effect until the [23-Over phase current delay] is set to 0 . The over current delay is inverse time, and the formula is $T=t/((IA/IT) - 1)^2$.
7	Over current recovery	0-500A (0A)	When over current occurs, it will enter the over current alarm delay state; if the current is less than the over current alarm value minus this difference, the over current alarm delay can be exited.
8	Over total power alarm	0-200% (100%)	Rated power multiplying by this value is regarded as over power alarm value. When the loading power is higher than the value and comes into delay but still higher (power faults delay), then

			over power alarms, If the value is set as 200, then the alarm is disabled.
9	Over total power delay	0-3600.0s (10s)	When this parameter is set to 0, the over power delay is the inverse time; if not, the over current delay is the time set for this parameter.
10	Over power 【inverse time】	0.1-36.0 (36.0)	This option will not take effect until the [24-Over total power delay] is set to 0 . The over power delay is inverse time, and the formula is $T=t/((IA/IT) -1)^2$.
11	Over power recovery	0-500Kw (0Kw)	When overpower occurs, it enters the overpower alarm delay state, the current power is less than the overpower alarm value minus this difference, and the overpower alarm delay can be exited.
12	Non-balance current ratio warning	10-100% (100%)	It is valid for 2P3W or 3P4W. When the non-balance current ratio is higher than the value and comes into delay but still higher (normal warn delay), then non-balance current ratio warns. If the value is set as 100, then the warning is disabled. $IOOB = ((I \text{ Max} - I \text{ Ave}) / Ave) * 100\%$
13	CT Sec. current	0-5A 1-50mA 2-62.5mA	Chose the secondary rated current.

5) Mains protection

No	Parameter	Range(defaults)	Notes
1	Phase	Disable(DC40 Series) 1 Phase 2 Wire 2 Phase 3 Wire 3 Phase 3 Wire 3 Phase 4 Wire(DC42 Series)	Choose the input, there is no display if setting as disable.
2	Mains under volt	55-330V (184V)	When the mains voltage is lower than the "low voltage crank threshold" and comes into mains low voltage delay (normal failure delay) but still lower, then mains becomes invalid. If the voltage become higher than "low voltage revert threshold" during normal failure delay time, then it will not alarm.
3	Revert under volt	55-330V (207V)	
4	Mains over volt	55-330V (276V)	When the mains voltage is higher than the "high voltage crank threshold" and comes into mains high voltage delay (normal failure delay) but still higher, then mains becomes invalid. If the voltage become lower than "low voltage revert threshold" during normal failure delay time, then it will not alarm.
5	Revert over volt	55-330V (253V)	
6	Mains normal delay	0.0-3600.0S (10.0S)	The time from abnormal to normal, which is used for ATS transfer.
7	Mains abnormal delay	0.0-3600.0S (5.0S)	
8	Loss of Phase judgment	Loss of Phase 1 Loss of Phase 2 Loss of Phase 3	Set the phase loss condition to judge whether the mains is abnormal.

6) Input setting

No	Parameters	Range(<i>defaults</i>)	Notes
1	Pressure/Temperature unit	°C/KPA °C/BAR °C/PSI °F/KPA °F/BAR °F/PSI	Unit display.
2	Coolant temperature sensor	0: Disable 1: Self-define resistance curve 2: VDO 40-120 °C 3: MEBAY-001B 4: SGH 5: SGD 6: SGX 7: CURTIS 8: DATCON 9: VOLVO-EC 10: 3015238 11: PT100 12: MEBAY-Mier 13: 13: WEICHAI 40-120°C 14: GENCON 40-120°C 15: From ECU	Choose the usual water temperature sensor, If the sensor used by the user is not the commonly used type, it can be User-defined.
3	Action if temperature sensor disconnected	Disable Warning Alarm and stop	Action if Water temperature sensor disconnected.
4	Temperature-up stop	20-200°C (68 °C)	When the temperature is over the preset value, then temperature-up procession is stopped in time.
5	High water temperature alarm	20-200°C (98 °C)	When the water temperature is higher than the alarm value and comes into high temperature delay but still higher (normal faults delay), then high temperature alarms. if the value is set as 200, then the high temperature alarm is disabled.
6	Action if high temperature	Warning Alarm and stop Alarm and stop after unloading	Alarm and stop: when the temperature is higher than preset value or high temperature signal is valid, then controller will alarm and stop after normal faults delay. If setting as warning: the AUX. input should be set as high temperature stop disabled and input is valid. When the temperature value is higher than the preset value or high temperature alarm input signal is valid, then controller only display warning

			<p>but not stop.</p> <p>If setting as alarm and stop after unloading:the AUX. input should be set as high temperature stop and input is valid. When the temperature value is higher than the preset value or high temperature alarm input signal is valid, then controller shall start the unloading procession and stop with alarm.</p>
7	Oil pressure sensor	0: Disable 1: Self-define resistance curve 2: Self-define voltage curve 3: Voltage type 1MPa-0-5V 4: Voltage type 1MPa-05-4.5V 5: VDO 0-10Bar 6: MEBAY-003B 7: SGH 8: SGD 9: SGX 10: CURTIS 11: DATCON 10Bar 12: VOLVO-EC 13: 3015237 14: WEICHA1 0-0.6Mpa 15: GENCON 0-10BAR 16: From ECU	Choose the usual oil pressure sensor, If the sensor used by the user is not the commonly used type, it can be User-defined.
8	Action if oil pressure sensor disconnected	Disable Warning Alarm and stop	Action if oil pressure sensor disconnected.
9	Low oil pressure alarm	0-999kpa (103kpa)	When the oil pressure is lower than the alarm value and comes into low oil pressure delay but still lower (normal faults delay), then low oil pressure alarms. if the value is set as 0, then the under speed alarm is disabled.
10	Action if low oil pressure	Warning Alarm and stop	If setting as warning,the AUX. input should be set as Low oil pressure stop disabled and input is valid. When the oil pressure value is lower than the preset value or low oil pressure alarm input signal is valid, then controller only display warning but not stop.
11	Fuel level sensor	0: Disable 1. Self-define resistance curve 2. 0-100Ω 3. 100-0Ω 4. 0-107Ω	If the sensor used by the user is not the commonly used type, it can be User-defined.

		5. 107-0Ω 6. 0-180Ω 7. 180-0Ω 8. 180-10Ω 9. 10-180Ω 10. 120-10Ω 11. 10-120Ω 12. 90-0Ω 13. 0-90Ω 14. 0-30Ω 15. 73-10Ω 16. 240-33Ω 17. 33-100Ω 18. 0-200Ω 19. 200-0Ω 20. 100-33Ω	
12	Action if fuel Level sensor disconnected	Disable Warning Alarm and stop	Action if Fuel level sensor disconnected.
13	Low fuel level warning	0-100% (20%)	When the fuel level is lower than the value and comes into low fuel level warning delay but still lower (normal warning delay), then low fuel level warns. If it is higher than the value then warning clears. If the value is set as 0, then the low fuel level warning is disabled.
14	Low fuel level alarm	0-100% (0%)	When the fuel level is lower than the alarm value and comes into low fuel level delay but still lower (normal faults delay), then low fuel level alarms. if the value is set as 0, then the low fuel level alarm is disabled.
15	AUX.INPUT 1	0-40 (18. Remote start)	Set the default value (please refer to the AUX. input function table)
16	AUX.INPUT 1 valid	0-Normal close 1-Normal open	
17	AUX.INPUT 2	0-40 (12. Gens un/loading input)	
18	AUX.INPUT 2 valid	0-Normal close 1-Normal open	
19	AUX.INPUT 3	0-40 (1. Low oil pressure alarm switch)	
20	AUX.INPUT 3 valid	0-Normal close 1-Normal open	
21	AUX.INPUT 4	0-40 (2. High water temperature alarm switch)	Set the state when the AUX. input is valid.
22	AUX.INPUT 4 valid	0-Normal close 1-Normal open	

AUX. input function table
0. Disable.
1. Low oil pressure alarm switch.
2. High temperature alarm switch.
3. Low water level warning switch.
4. Low water level alarm switch.
5. Low fuel level warning input.
6. Low fuel level alarm input.
7. Charging failure warning: output when charging failure.

8. Low oil pressure shutdown disabled: valid if there is signal input.

9. **High temperature shutdown disabled:** valid if there is signal input.
10. **External instant warning input.**
11. **External instant alarm input.**
12. **Gens un/loading input:** connect to the gens loading switches auxiliary point.
13. **Mains un/loading input:** connect to auxiliary point of mains loading switch.
14. **Shades status input.**
15. **Auto start disabled:** gens will not start if there is signal input whatever mains normal or not.
16. **Auto stop disabled:** gens will not stop if there is signal input whatever mains normal or not.
17. **Stop by radiator if high temperature:** The controller will shutdown the gens after high speed cooling down delay when temperature is too high if this signal is valid and gens under normal running . the controller will shutdown the gens directly if the signal is not valid.
18. **Remote start(with load):** the gens comes into start procession if this signal is valid and under auto mode.
19. **Soundproof alarm:** audio alarm output is disabled if there is signal output.
20. **Front face button disabled:** any button except for page button is disabled if there is signal output.
21. **Meter mode:** all output are disabled, alarm and warns are invalid. any button except for page button is disabled.
22. **Remote control mode:** any button except for page button is disabled if the input is valid, LCD will display remote mode.remote control module can start/stop and monitor parameters through front face buttons.
23. **Idle speed input:**When the input port is valid, the idle speed control is output, and the low speed alarm is invalid.
24. **Emergency stop alarm input;**
25. **Broken fan belt input;**
26. **Remote start(without load):** the gens comes into start procession(without load) if this signal is valid and under auto mode.
27. – 40. **Reserved.**

7) Output setting

1	AUX.OUTPUT 1	0-50(1. Public warning output)	Set the default value (please refer to the AUX. Output function table)
2	AUX.OUTPUT 2	0-50(2. Public alarm output)	
3	AUX.OUTPUT 3	0-50(17.E.S.T. hold)	
4	AUX.OUTPUT 4	0-50 (10. Idle speed control)	

AUX. Output function table

0. **Disable.**
1. **Public warning output:** when there is any warning output.
2. **Public alarm output:** when there is any alarm output, alarm locks till revert back.
3. **Audio alarm:** when there is any alarm output, the Audio controls.
4. **Shades control:** there is output once genset starts and stop till stable.
5. **Preheat mode 1:** preheat before start.
6. **Pre-oil supply control:** Under pre-oil supply,if the oil pressure is higher than setting value or pre-oil supply time ends, then pre-oil supply stopped.
7. **Fuel output:** output once gens starts and off till stable.
8. **Crank output:** output once cranking, no output in other mode.
9. **Genset running:** output under running,off once RPM is lower than cranking RPM. The crank success condition can be set.

10. **Idle speed control 1:** used for speed controller, there is output under idle but no output under high speed.
11. **Speed-up control:** during the procession of speed increasing, the output time is the Longest RPM-up time.
12. **High speed control:** The output is valid after idle delay is completed, and the output is closed after high-speed heat dissipation.
13. **Excitation output:** there is output during cranking procession and there is 2s output if there is no frequency under high speed status.
14. **Gens load:** continuous or pulse type according to time setting.
15. **Gens unload:** continuous or pulse type according to time setting.
16. **Speed-down control:** the output time is shutdown idle delay during shutdown idle or shutdown on power procession.
17. **E.S.T. hold:** shutdown output, it is used for gens with stop solenoid. when the setting value of shutdown delay is over, then it is off.
18. **System in stop:** there is output under stop mode.
19. **System in manual:** there is output under manual mode.
20. **System in auto:** there is output under auto mode.
21. **Fuel pump output:** there is output if the oil capacity is lower than start condition for 10s and shutdown if it is higher than the shutdown condition for 1s.
22. **Battery charging control:** there is output if the voltage is lower than the preset value under standby status and shutdown after start and in running status.
23. **Mains load:** continuous or pulse type according to time setting.(No functionality when AMF is disabled)
24. **Mains unload:** continuous or pulse type according to time setting. (No functionality when AMF is disabled)
25. **Idle speed control 2:** used for speed controller, there is output under idle but no output under high speed.
26. **Rated running:** there is output under rated running.
27. **ECU power:** apply to electrical ECU engine, used for control ECU power.
28. **ECU stop:** apply to electrical ECU engine, used for control ECU shutdown.
29. **ECU warning:** there is a warn signal from ECU.
30. **ECU alarm:** there is an alarm signal from ECU.
31. **ECU communication failure:** Cannot communicate with ECU.
32. **Fan control:** When the engine temperature is higher than the "open fan temperature value", it will output, and it will be disconnected when it is lower than the "close fan temperature value".
33. **Pulse speed up output:** the pulse shall be sent out in the interval of "Pulse speed up delay" under speed -up.
34. **Pulse speed down output:** the pulse shall be sent out in the interval of "Pulse speed down delay" under stop idle speed.
35. **Public unload:** Public unload of Gens and Mains.
36. **Preheat mode 2:** Preheat stops after successful start.
37. **Preheat mode 3:** Preheat stops after safety delay.
38. **Preheat mode 4:** Preheat stops after Temp.-up time.
39. **Preheat mode 5:** Preheat stops after Temp.-up time, no preheat start the motor;
40. **-50: Reserved**

8)CAN communication

NO	Parameter	Range(<i>default</i>)	Notes
1	CAN failure	Disable Warn	ECU communication failure.

		Alarm and Stop	
2	ECU warning	Disable/ Enable	ECU warnings enable.
3	ECU alarm	Disable/ Enable	ECU alarms enable.
4	Mask SPN	0-12	Up to 12 sets of alarm codes can be input, and the controller will not respond to the input alarm codes.
5	Rated idle speed	500-4500rpm (750rpm)	ECU idle speed value.
6	Slow rise time	0-120.0S (5.0S)	The time of ECU from idling to high speed.
7	ECU speed control address	0-255 (3)	The TSC1 message ID address sent by the controller to the ECU, and the communication protocol must be 31: J1939-C.
8	CAN communication rate	0-250Kbps 1-500Kbps	CAN communication rate

9)Module settings

NO	Parameter	Range(default)	Notes
1	Language	0-English 1-简体中文 2-繁体中文 3-español 4-русский 5-Türk dili 6-Français 7-Românesc 8-Polski 9-Português 10-Deutsch 11-한국어 12-Tiếng Việt 13-العربية 14-Bahasa Indonesia 15-فارسی ;	Display language selection. 0: English, 1: Simplified Chinese, 2: Traditional Chinese, 3: Spanish, 4: Russian, 5: Turkish, 6: French, 7: Romanian, 8: Polish, 9: Portuguese, 10: German, 11: Korean, 12: Vietnamese, 13: Arabic, 14: Bahasa Indonesia, 15: Persian.
2	Host and slave mode	0: Host mode 1: Slave mode	Select the instrument communication mode, the host can read and display the parameters of the slave through the RS485 port.
3	User password	00000-65535 (07623)	Change the password.
4	Controller ID	1-255 (16)	The IP built by controller and PC.
5	RS485 baud rate	0-4800 1-9600 2-19200 3-38400 4-57600 5-115200	RS485 communication baud rate.
6	Primary Modes	STOP Manual	The primary modes on power, easy for user operation.

		Auto Auto save	Note: auto record function can't record the mode with load.
7	Start screen display time	0-20.0s (5.0s)	Start screen display time,0: No-display.
8	LCD contrast	50-127 (106)	Set the LCD display contrast.
9	Saving mode	5.0-6000.0s (600.0s)	LCD light will be closed automatically without any button pressed after delay. If setting as 6000.0s, back light always lighted.
10	Homing display	5.0-600.0s (600.0s)	The time when the page reverts back to the home page. If setting as 600.0s: disabled.
11	LOGO delay display under standby	5.0-6000.0 (6000.0s)	Start screen will be opened without any button pressed after delay. If setting as 6000.0s: disabled.
12	ECU page	Disable/ Enable	Set whether the ECU page is displayed.

a) Working plan and maintenance setting

No	Parameter	Range(defaults)	Notes
1	Working plan format	Disable Every month Every week	This mode must be under auto mode. Working plan is disabled once setting as disable. The working plan will be executed according the chosen date when setting as every month. The working plan will be executed according the chosen date when setting as every week.
2	Maintenance date per month	From 1 st to 31 st Default: the first day	The date chosen for every month.
3	Maintenance date per week	Monday to Sunday Default: Sunday	The date chosen for every week.
4	Maintenance with load or not	Disabled /with load	To choose if the genset starts with load or not.
5	Maintenance start time	00:00-23:59(00:00)	Maintenance start time setting.
6	Maintenance running time	1-120m(5min)	Maintenance running time setting.

b) working plan

No	Parameter	Range(default)	Notes
1	Working plan	Disable Enable 1: remote start Enable 2: mains failure Enable 3: the above 1 or 2 Enable 4:running always	Working plan start condition.
2	Start time	00:00-23:59 (08:00)	The start time allowed.
3	End time	00:00-23:59 (17:00)	The end time allowed (the next day is valid).
4	Dates	1-31	Multiple choices according to the reality. The longest running time is 24 hours.

c) Maintenance plan

No	Parameter	Range(defaults)	Notes
1	Maintenance countdown	0-5000h(5000h)	When it is set as 5000, then this function is disabled.
2	Maintenance date	2000/01/01-2099/12/31	When it is set as 2000/01/01, this function is disabled.
3	Maintenance expire	Warning Alarm and stop	The action after the primary maintenance expired.

d) Data/time setting

No	Parameter	Range(defaults)	Notes
1	Date/Time	2000/01/01-2099/12/31	Internal calendar, please calibrate regularly.
2	Current time	00:00:00-23:59:59	
3	Current week	Monday to Sunday	

e) Self-define curve

NO	Parameter	Notes
1	Self-define oil pressure resistance curve	Sensor curve can be User-defined by panel buttons, resistance and according value should be input, MAX 15 groups, MIN 2 groups.  Rule: resistance should be input from small to large.
2	Self-define oil pressure voltage curve	
3	Self-define water temperature curve	
4	Self-define fuel level curve	

12. Fault finding

Symptoms	Possible Solutions
Controller no response with power	Check DC voltage. Check DC fuse. Check if the terminal 1 and 2 is with battery voltage.
Genset shutdown	Check the water/cylinder temperature is too high or not. Check the genset AC voltage. Check DC fuse.
Genset Emergency Stop	Check whether the emergency stop button is normal; Check whether the AUX.INPUT is configured correctly; Check whether the controller cable is normal.
Low oil pressure alarm	Check oil pressure sensor and its wiring. Check the oil pressure sensor type and controller settings must be consistent. Check whether the low oil pressure sensor is normal.
High temperature alarm	Check temperature sensor and its wiring. Check the temperature sensor type and controller settings must be consistent. Check whether the temperature sensor is normal.
Shutdown Alarm in running	Check related switch and its connections according to the information on LCD. Check AUX.INPUT.
Fail to start	Check fuel return circuit and wiring. Check start battery. Consult engine manual.
Starter motor does not respond	Check the wiring to the starter. Check start battery.
Unit operation but ATS	Check the ATS.

does not switch	Check the cable between the controller and the ATS.
USB communication is abnormal	Check the USB connection. Check whether the USB port of the computer is normal. Check whether the USB driver is installed.
RS485 cannot communicate normally	Check the connection. Check if the communication ID number setting is correct. Check if the A and B lines of RS485 are reversed. Check if the RS485 communication line driver is installed or not. Check if the communication port of the PC is damaged. Add a 120 Ω resistor between the AB of the controller RS485.
ECU warning or stop	Get information from LCD of alarm page; If there is detailed alarm, check engine according to description. If not, please refer to engine manual according to SPN alarm code.