

DECLARATION
No part of this publication may be reproduced, stored in a retrieval system, or transmitted in any form by any means, electronic, mechanical, photocopying, recording, or otherwise without prior permission of Aisikai. All rights reserved.
This company reserves power or revision of product specification described in this manual without notice. Before ordering, please consult local agent for the latest specification of product.



AISIKAI-2019ATSCSG-V1.2

© AISIKAI ELECTRIC COPYRIGHT



Wechat



Contact

AiSIKAI®

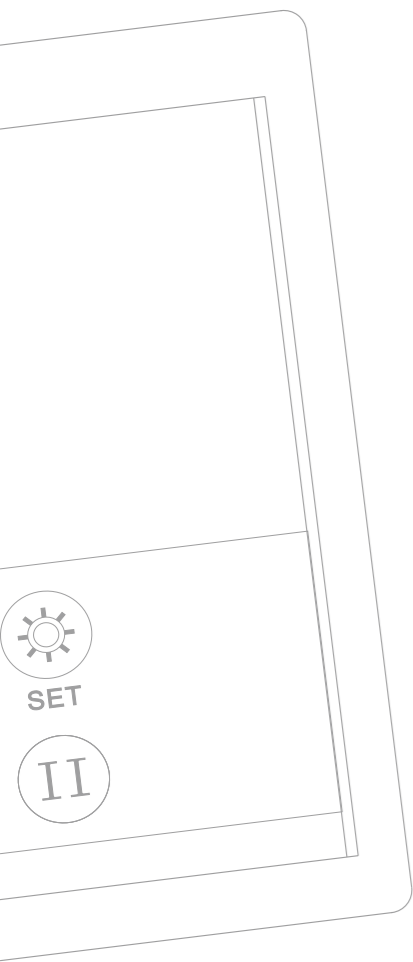
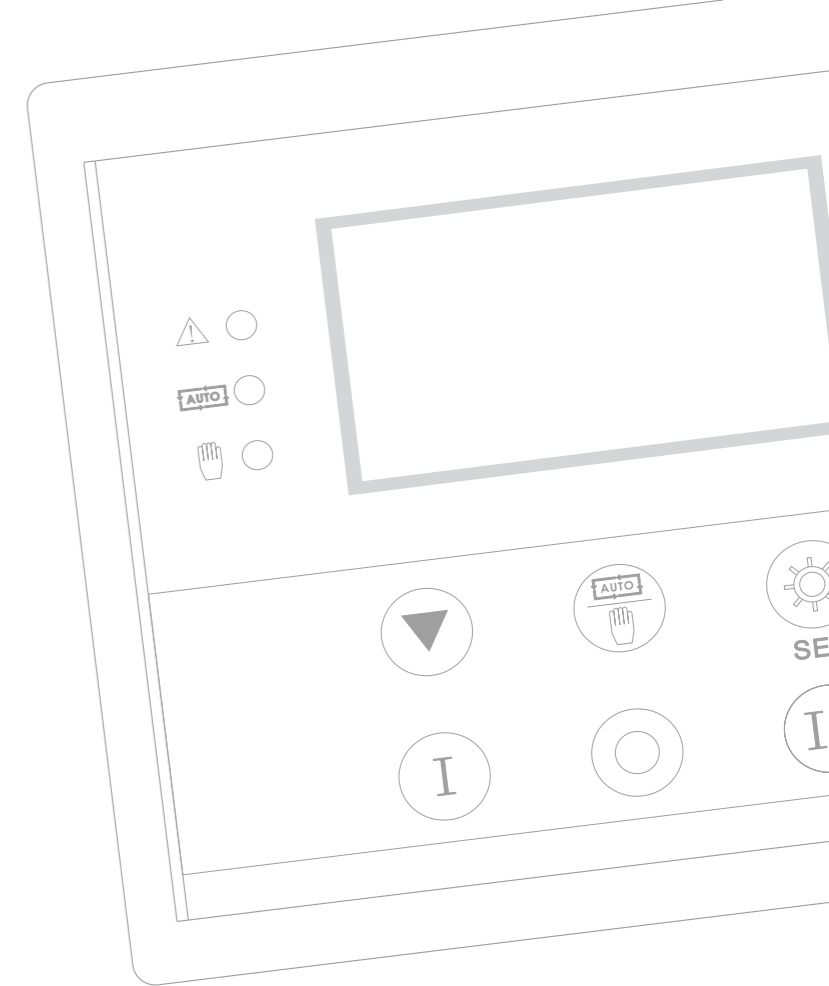

AUTOMATIC TRANSFER SWITCH CONTROLLER SELECTION GUIDE

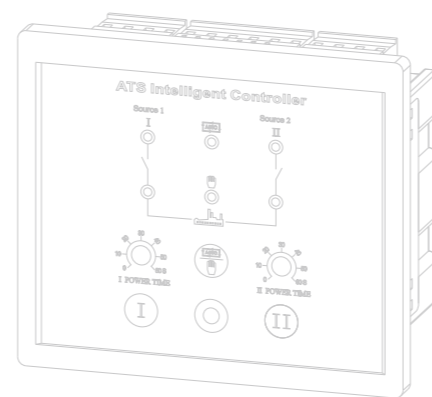

JIANGSU AISIKAI ELECTRIC CO.,LTD
www.aisikai.cc

YANGZHOU AISIKAI AUTOMATION TECHNOLOGY CO.,LTD
www.aisikai.org

Tel: +86-514-83872777 83872888

Fax: +86-514-83872000

Free Service Telephone: 800-828-6568

E-mail: aisikai@aisikai.cc

Factory Add: NO.5 Chuangye Road, Chenji Industrial Zone,
Yizheng City, Jiangsu Province China

JIANGSU AISIKAI ELECTRIC CO.,LTD



AUTOMATIC TRANSFER SWITCH CONTROLLER

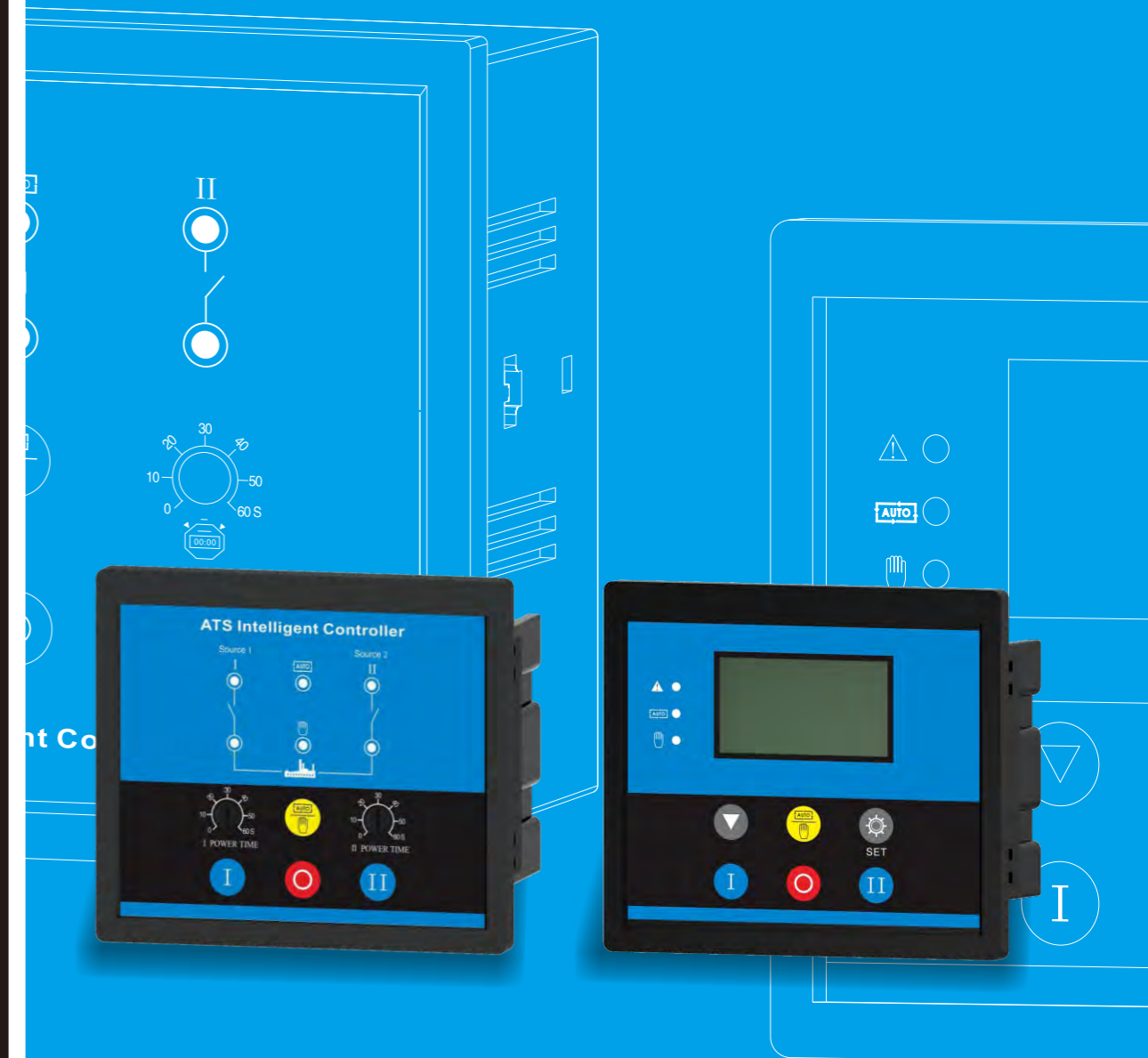

ATSC

SKR2-A Series automatic transfer switch controller

Product overview



- SKR2-A automatic transfer switch controller is based on the micro-processor core. It can accurately detect the three phases/ single phase voltage of the dual power supplies, make accurate judgement of voltage anomalies (power loss, over voltage, under voltage, phase missing, over frequency, under frequency), and control the switching of ATS after delay. It is suitable for the ATS with one breaking position or no breaking position. Controllers have the function of sending generator start signal after delay when power 1# becomes abnormal. Using RS485 communication interface, controllers realize functions of remote measurement, remote communication and remote control.

Performance Feature

- Collect and display the 3 phases voltage and frequency of dual power supplies;
- Through panel keys users can set the parameters like "1# power has transferring priority", "2# power has transferring priority", "no priority", "automatic/manual", etc.
- Breaking and closing output is pulse output.
- Dual N lines are separated in design.
- Have automatic/manual mode switching function. In manual mode, pressing the keys on panel to control the switching of ATS.
- Panel LED can display the ATS working status clearly.
- Have the force open input port. When it's active, ATS is forced to the breaking position (only effective for the ATS with breaking position).
- Equipped with programmable relays (AUX.OUTPUT1, AUX.OUTPUT2), which can control the switching of the power supply of ATS.
- 1#, 2# power switching relays (1#COLSE, 2#CLOSE, OPEN) output contacts capacity is 5A AC25V. All contacts are passive contacts and can be used to drive the ATS switching.
- Generator start relay (GENS START) output contact capacity is 7A AC250V / 7A DC28V ant it's passive closing contact.
- Modular structure design. Flame-retardant ABS shell. Pluggable wiring terminal. Embedded installation method. Compact structure. Easy installation.

Application area



Working conditions and installation modes

Category	Description
Working conditions	Temperature: (-25+70) °C Wumidity: (20~90) % ;
Storage conditions	Temperature: (20~90) % ;
Protection level	Ip55: When the waterproof rubber ring is strengthened between the controller and the control panel IP42: When the waterproof rubber ring not strengthened between the controller and the control panel
Insulation strength	Object: Between Input/Output/Power Supply Reference standard: IEC688-1992; Test method: AC 1.5KV/1min leakage current 5mA
Installation mode	Installed in non-vibration electric cabinet

SKR2-A Series automatic transfer switch controller

Operation panel description

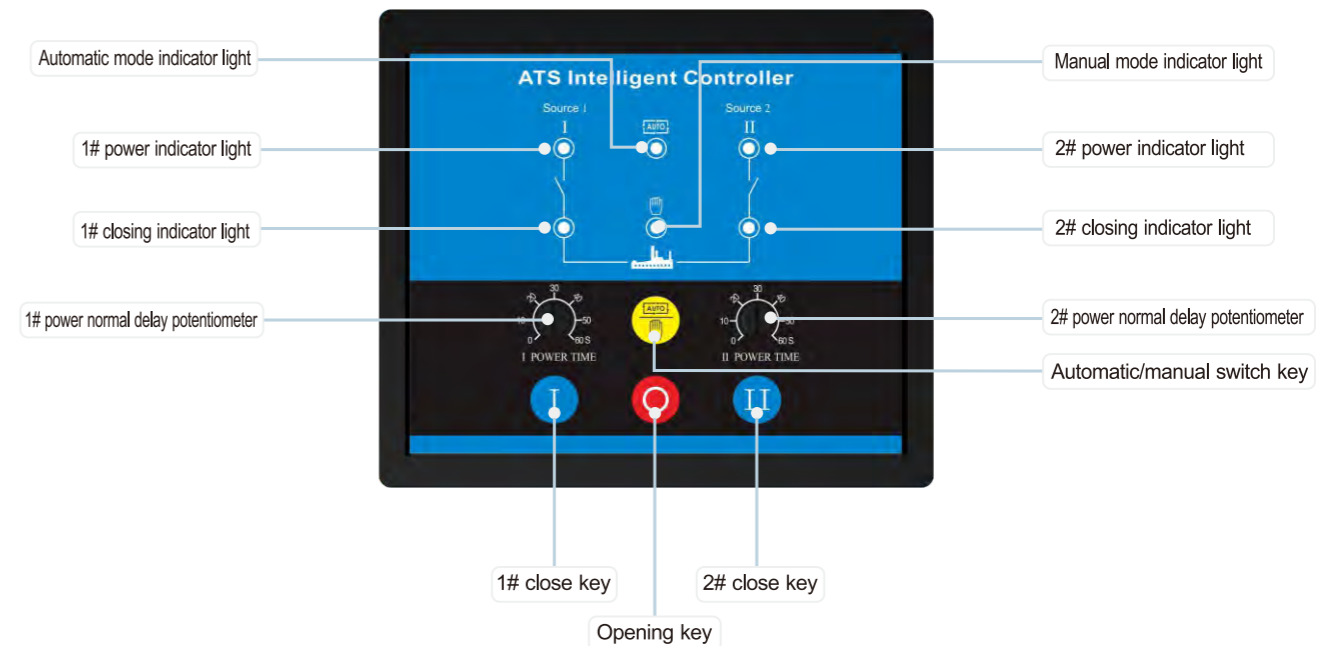

Specification

Item	Content
Working voltage	AC power L1N1/L2N2 supply, voltage range AC170V~277V.
Overall power consumption	≤3W (Standby mode: < 1W)
AC voltage input	3 phases 4 lines(ph-N) AC170V~AC277V
	Single phase 2 lines(ph-N) AC170V~AC277V
	2 phases 3lines(ph-N) AC170V~AC277V
Rated frequency	50/60Hz
1# closing relay output port	5A AC250V Passive output
2# closing relay output port	5A AC250V Passive output
Breaking relay output port	5A AC250V Passive output
Relay output 1	10A AC250V Passive output
Relay output 2	10A AC250V Passive output
Generator start relay	7A AC250V Passive output
1# closing input port	Effective when connect with COM2
2# closing input port	Effective when connect with COM2
Force open input port	Effective when connect with COM2
Communication	RS485 interface, MODBUS protocol
Outline dimensions	139mm×120mm×48mm
Hole dimensions	130mm×111mm
Working conditions	Temperature: (-25~+70 °C) Relative humidity: (20~93)%RH
Storage conditions	Temperature: (-25~+70 °C)
Protection level	IP55 when waterproof rubber ring is mounted between controller and control panel.
Insulation strength	AC2.2kV voltage is applied between AC high voltage terminal and low voltage terminal, the leakage current is no larger than 3mA in 1 minute.
Weight	0.51kg

Panel operation of parameters setting

1. Entering and exiting parameters setting mode

Press **⏻** key and hold, after 3s, controller all LED lights are on and controller enters light-test mode. Keep pressing **⏻** key, after 7s, controller all LED lights flash(500ms one time) and controller enters parameter setting mode. Release **⏻** key, if you want to cancel the setting, press **⏻** key, controller all LED lights flash 5 times (200ms one time) and controller returns normal test mode. In light-test mode, release **⏻** key, controller returns normal test mode. In parameters setting mode, if no parameters are set, controller automatically returns normal test mode after about 1'30''.

2. Transferring priority setting

Firstly enter the parameter setting mode before setting transferring priority.

The procedure of setting “1# power has transferring priority”, “2# power has transferring priority” and “no priority”:

a. Press and hold **⏻** key, **⏻** key and **⏻** key simultaneously. Release **⏻** key, **⏻** key and **⏻** key when 1# power indicator light, automatic mode indicator light and 2# power indicator light come on simultaneously. Automatic mode indicator light and 2# power indicator light go out, 1# power indicator light is on, then controller enters transferring priority setting mode.

b. Press **⏻** key can set controller in 3 power supply modes circularly.

When 1# power indicator light is on and 2# power indicator light is off, 1# power has transferring priority.

When 2# power indicator light is on and 1# power indicator light is off, 2# power has transferring priority.

When both 1# and 2# power indicator lights are on, there's no transferring priority.

c. After setting, press **⏻** key, when 1# power indicator light, automatic mode indicator light and 2# power indicator light are on, means the transferring priority setting value is saved successfully. All lights on panel flash 5 times quickly and controller returns normal test mode. The controller will operate according to the just set priority.

Every time turn on the controller power, the current transferring priority setting can be judged according to the 3 conditions below.

——If 1# power indicator light flashes 3 times quickly, 1# power has priority.

——If 2# power indicator light flashes 3 times quickly, 2# power has priority.

——If both 1# and 2# power indicator lights flash 3 times quickly, there's no priority.

3. AC wiring system setting

Firstly enter the parameter setting mode before setting the AC wiring system.

The procedure of setting AC wiring systems (single phase 3 lines, 3 phases 4 lines, 2 phases 3 lines):

a. Press down **⏻** **⏻** **⏻** simultaneously. Release **⏻** **⏻** **⏻** when 1# power indicator light, automatic mode indicator light and 2# power indicator light come on simultaneously. Automatic mode indicator light and 2# power indicator light go out, 1# power indicator light is on.

b. Press **⏻** key. Release **⏻** key when 1# power indicator light, automatic mode indicator light and 2# power indicator light come on simultaneously. 1# power indicator light, automatic mode indicator light and 2# power indicator light go out simultaneously, then controller enters AC wiring system setting mode.

c. Press **⏻** key can set controller in 3 AC wiring systems circularly.

When 1# close indicator light is on, the setting is 2 lines system;

When 1# close indicator light, manual mode indicator light and 2# close indicator light are on, the setting is 3 phases 4 lines system;

When 1# close indicator light and manual mode indicator light are on, the setting is 2 phases and 3 lines system.

d. After setting, press **⏻** key, when 1# power indicator light, automatic mode indicator light and 2# power indicator light come simultaneously, means the AC wiring system setting is saved successfully. All lights on panel flash 5 times quickly and controller returns normal test mode. The controller will operate according to the just set wiring system.

Every time turn on the controller power, the current wiring system setting can be judged according to the 3 conditions below.

——If 1# close indicator light is on, it's single phase 2 lines

——If 1# close indicator light, manual mode indicator light and 2# close indicator light are on, it's 3 phases 4 lines.

——If both 1# and manual mode indicator lights are on, it's 2 phases 3 lines.

4. Delay setting

Adjust “1# power normal delay” potentiometer, can set the output delay after 1# power getting normal (potentiometer is at the side of the back-panel terminal).

Adjust “2# power normal delay” potentiometer, can set the output delay after 2# power getting normal (potentiometer is at the side of the back-panel terminal).

Firstly enter the parameter setting mode before setting the delay.

The procedure of setting “1# power abnormal delay”, “2# power abnormal delay”:

a. Press down **⏻** key, **⏻** key simultaneously. Release **⏻** key, **⏻** key when 1# power indicator light, automatic mode indicator light and 2# power indicator light come on simultaneously. 1# power indicator light, automatic mode indicator light and 2# power indicator light go out simultaneously, then controller enters delay setting mode.

1# power abnormal delay: adjust the “1# power normal delay” potentiometer.

2# power abnormal delay: adjust the “2# power normal delay” potentiometer.

b. After setting, press **⏻** key, when 1# power indicator light, automatic mode indicator light and 2# power indicator light come on simultaneously, means the value set by potentiometer is saved successfully. All lights on panel flash 5 times quickly and controller returns normal test mode. The controller will operate according to the just set delay value.

Note: 1# power normal delay value should be no less than 1# power abnormal delay value, otherwise 1# power normal delay value will be forced to the value of 1# power abnormal delay. 2# power normal delay value should be no less than 2# power abnormal delay value, otherwise 2# power normal delay value will be forced to the value of 2# power abnormal delay.

5. Restore the factory delay value

Firstly enter the parameter setting mode.

a. Press down **⏻** **⏻** key simultaneously. Release **⏻** **⏻** key when 1# power indicator light, automatic mode indicator light, and 2# power indicator light come on simultaneously. 1# power indicator light, automatic mode indicator light and 2# power indicator light go off simultaneously, then controller enters the delay value setting mode.

b. Press **⏻** key, when 1# power indicator light, automatic mode indicator light and 2# power indicator light come on simultaneously, means delay value is restored to factory setting. All indicators on panel flashes 5 times and controller return to normal test mode. Controller will work according to the factory setting delay value.

Note: 1#, 2# power abnormal delay factory setting value is 5 seconds. Generator shutdown delay factory setting value is 90 seconds.

Input/output interface diagram

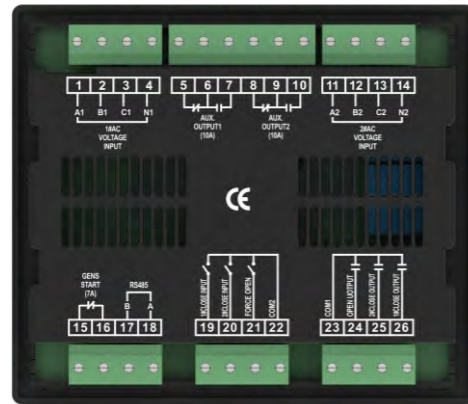

SKR2-A controller input output interface diagram

Wiring terminal function description

Terminal number	Item	Function description	Remark	
1	A1	1# AC 3 phases 4 lines voltage input	If single phase input, only A1 and N1 are used	
2	B1			
3	C1			
4	N1			
5	Output port 1	Normally close	ATS power phase A	Passive relay contact output, rated 10A
6		Common terminal		
7		Normally open		
8	Output port 2	Normally close	ATS power phase N	Passive relay contact output, rated 10A
9		Common terminal		
10		Normally open		
11	A2	2# AC 3 phases 4 lines voltage input	If single phase input, only A2 and N2 are used	
12	B2			
13	C2			
14	N2			
15	Start output	Passive relay contact output	Normally close output, rated 7A	
16				
17	B	RS485 communication interface		
18	A			
19	1# close input	Detect 1# closing state, auxiliary contact input	Effective when connect with COM2	
20	2# close input	Detect 2# closing state, auxiliary contact input	Effective when connect with COM2	
21	Force open	Make ATS transfer to the open position when effective	Effective when connect with COM2	
22	Common terminal	Input common terminal	COM2	
23	Output common terminal	COM1	Close, Opening output common terminal	
24	Opening output	Passive relay contact output	Normally open contact output, rated 5A	
25	2# close output	Passive relay contact output	Normally open contact output, rated 5A	
26	1# close output	Passive relay contact output	Normally open contact output, rated 5A	

Note: COM1 is output common terminal, COM2 is input common terminal, they cannot be connected with each other.

SKR2-A controller Wiring schematic diagram(1)

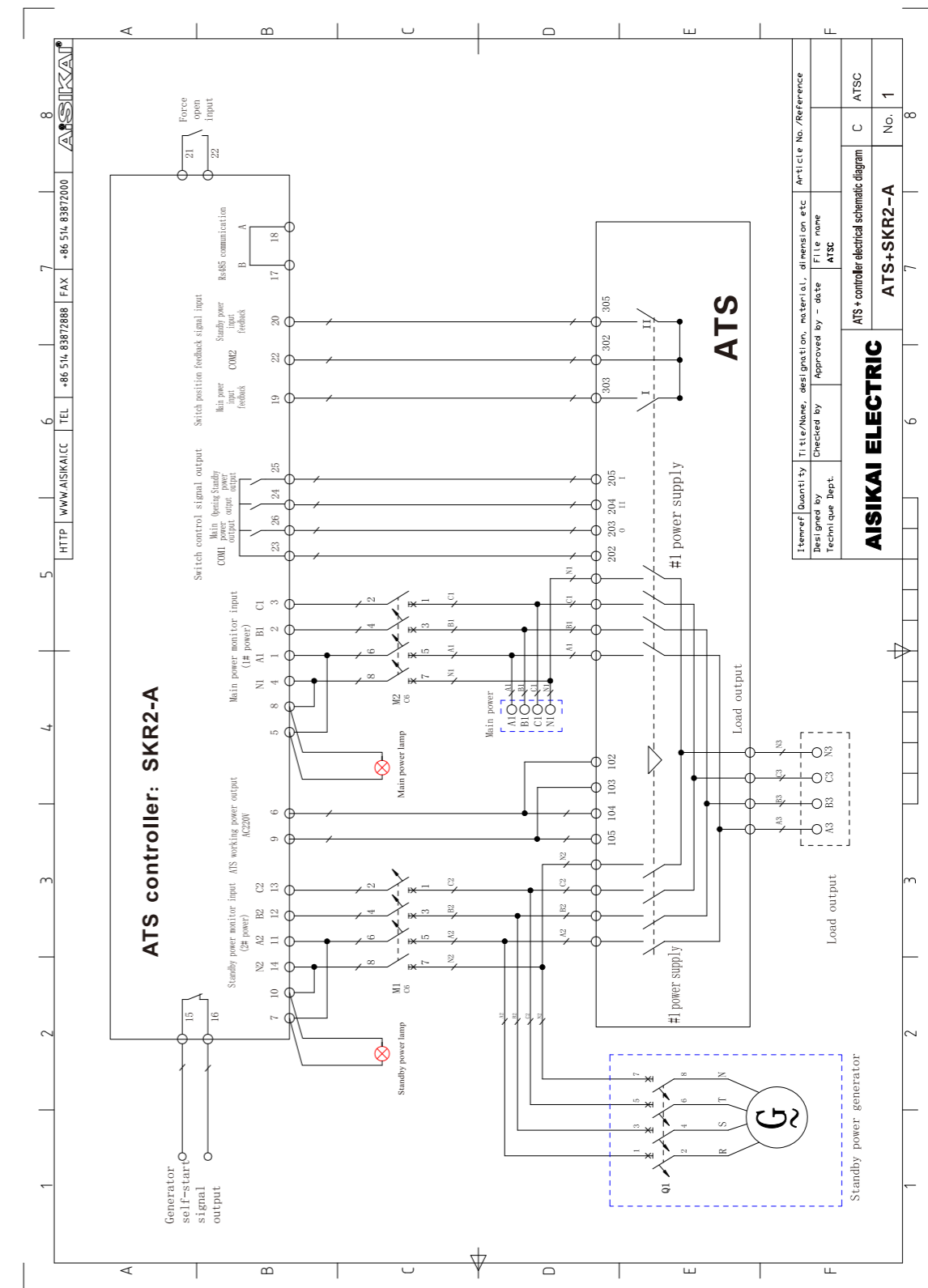

SKR2-A controller Wiring schematic diagram(1)

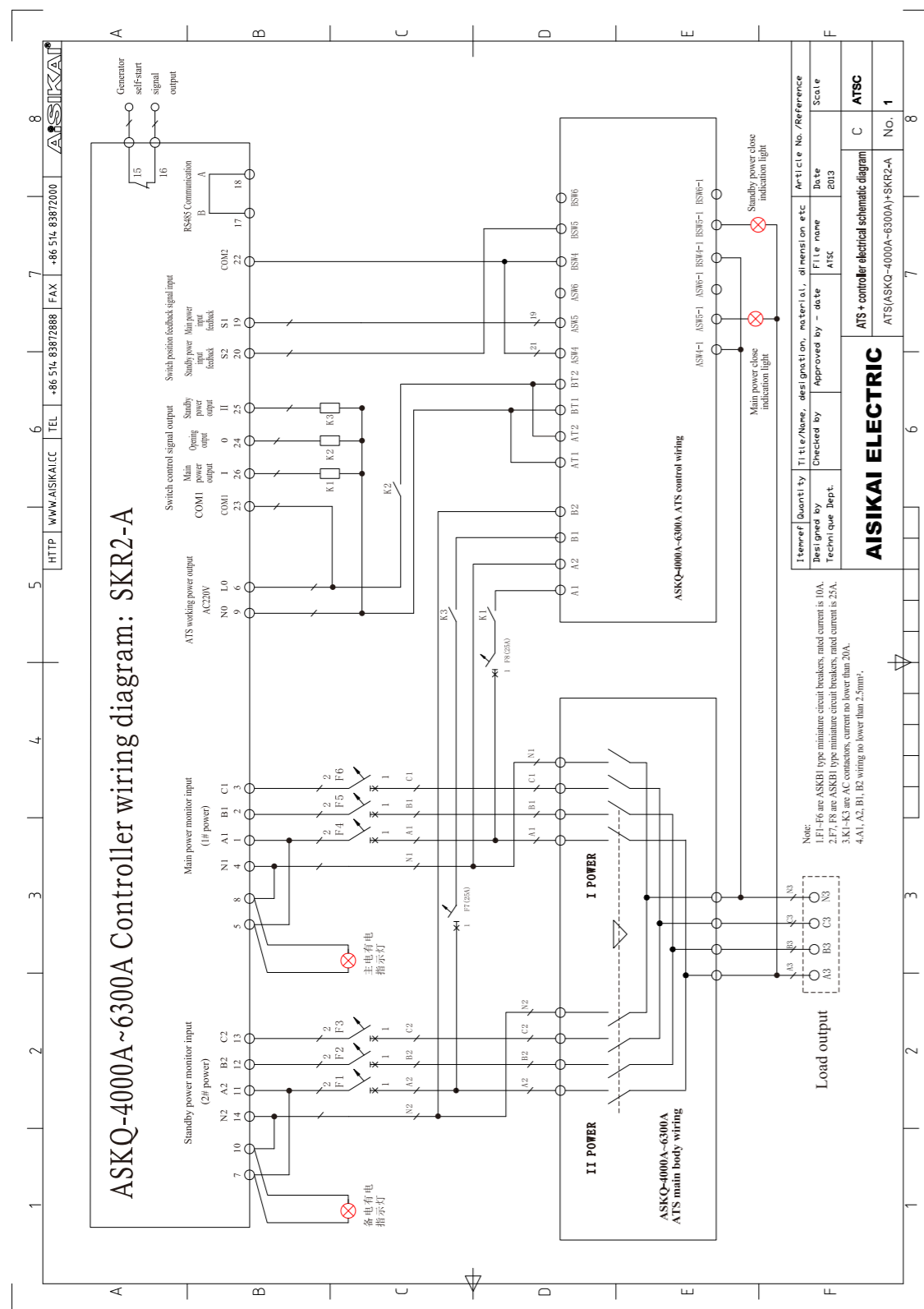

SKR2-B series automatic transfer switch controller

Product overview



Characteristics

- ASKR2-B ats controller is an intelligent dual-power switching module with programmable function, automatic measurement, LCD display and digital communication. It integrates digitalization, intellectualization and networking. It realizes automation of measurement and control process and reduces human errors. It is an ideal product for dual power switching.
- ASKR2-B ats controller is composed of microprocessor. It can accurately detect two three-phase/single-phase voltages, accurately judge the voltage anomalies (overvoltage, undervoltage, phase-gap, overfrequency, underfrequency) and output the passive control switching quantity. The device fully considers the application of various ATS (load automatic conversion system), and can be directly used for special ATS switch, ATS consisting of contactor, ATS consisting of air switch, etc. Its compact structure, advanced circuit, simple wiring, high reliability, can be widely used in power, post and telecommunications, petroleum, coal, metallurgy, railway, municipal, intelligent building behavior, part of the electrical equipment, automatic control and debugging system.
- LCD is 128*84, with backlight, two languages (Simplified Chinese and English) display, button operation.
- Has functions of over voltage, under-voltage, phase loss, reverse phase sequence, over frequency and Under-frequency.
- Has automatic / manual state, in manual mode, it can be forced to switch on or off.
- All parameters are programmable on site, using two level password to prevent non professional to incorrect operate.
- Can be set as on-load/off-load mode for test operation of generating units on site.
- It has switch reclosing and power-off reclosing functions.
- Closing output can be set to pulse or continuous output.
- Apply to one breaking terminal, two breaking terminals and NON breaking terminal
- Two N lines are isolated by voltage transformer.
- Real-time clock display.
- It has the function of timed start-up and shut-down of generating units. It can be set to run single time, once a month or once a week, and can also set whether to run on-load or not.
- The cycle operation of two generators can be controlled, and the running time and the interval shutdown time of the generators can be set.
- DC power supply or AC power supply.
- Standard 485 communication interface with ModBus communication protocol, has remote control, remote communication, remote detection "three remote" function.
- Current controller status can be queried (current status of input port and output port, circuit abnormalities such as over-voltage, under-voltage, over-frequency, under-frequency, etc.)

Technical parameter

Item	Content
Working voltage	1、DC 8.0V to 35.0V continuous power supply. 2、AC power L1N1/L2N2 supply, Voltage range AC (170~277) V.
Overall Power Consumption	≤3W(Standby mode: <2W)
AC voltage input	Three-phase Four-wire (ph-N) AC170V~AC277V
	Single-phase Two-wire (ph-N) AC170V~AC277V
	Two-phase Three-wire (ph-N) AC170V~AC277V
Rated frequency	50/60Hz
Closing relay output	5A AC250V Passive output
Programmable relay output 1	7A AC250V Passive output
Programmable relay output 2	7A AC250V Passive output
Programmable relay output 3	16A AC250V Passive output
Programmable relay output 4	16A AC250V Passive output
Digital value input	Grounding connection is active
Communication mode	Rs485 isolated interface, MODBUS protocol / front-end intelligent device protocol(YD/T 1363.3-2005)
Controller size	139mm×120mm×48mm
Install hole size	130mm×111mm
Working conditions	Temperature:(-25~+70)°C Relative humidity:(20~93)%RH
Storage conditions	Temperatur:(-25~+70)°C
Protection level	IP55: When the controller and control panel bracket are equipped with waterproof rubber ring
Insulation strength	Add AC 2.2kV voltage between AC high voltage terminal and low voltage terminal, and the leakage current in 1 minute is not more than 3 mA.
Weight	0.62kg

Operation panel

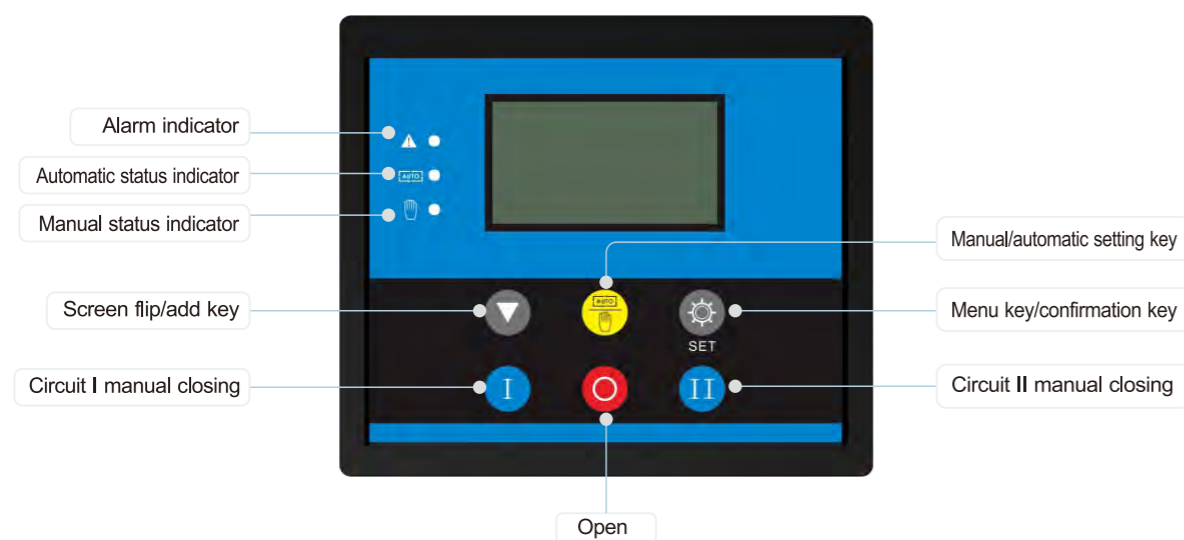

ATS operation

● Manual mode

- Press the key: The manual status indicator is on and the controller is in the manual state.
- Press the key: circuit I closing relay output, if circuit I closing indicator lights up, it means circuit I on load.
- Press the key: circuit II closing relay output, if circuit II closing indicator lights up, it means circuit II on load.
- Press the key: switch relay output, if I and II closing indicator lights are not on, it means switch off.

● Auto Mode

Press the key, auto mode indicator light is on, controller is in auto mode, the ATS will "CLOSE" or "OPEN" according to the status of #I and #II power supply. It will transfer according to the pre-set priority if #I and #II are both normal. If there is no priority, ATS will choose the current under working power supply until it gets abnormal and ATS will transfer to the other power supply automatically.

LCD interface

Main Interface (Electricity Parameter Interface), Press Key to read

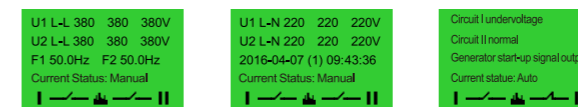

Main menu interface



- Press the key under the main interface to enter the main menu interface
- Press the key to select different parameters, and then press the key to confirm, you can enter the corresponding display interface.

Parametric Configuration Interface



- In the main interface, press key, select "2. Parameter settings", and then press key again to enter the parameter settings password confirmation interface.
- Press to input the corresponding password 0~9, press key to right move the bit, in fifth bit press key to check password. If the password is correct, enter into parameter setting interface, otherwise, exit directly. **Factory default password :12345**
- In the parameter configuration interface, long press the key to exit the interface directly and return to the main display interface.

Records display

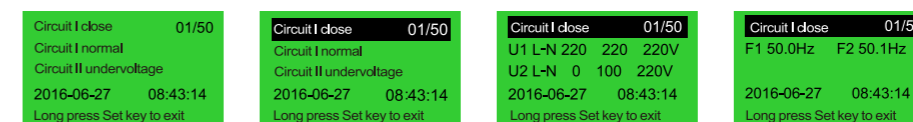

- Under the main interface, press the key, select "3.records", and then press the key to determine, you can display the controller history records information.
- Press the key to select the appropriate record, press the key in the current record, and enter the detailed information display interface of the record.
- In the detailed history interface, press the key to display detailed information in the current record, including recording the voltage situation of the circuit I and I at that time and the specific voltage, frequency, date and time. Exit the record by key, Long press the key to exit the history query and return to the main interface.

Terminals display

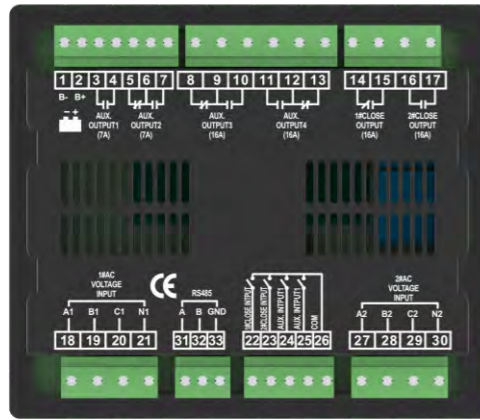

Terminals instruction

Terminal No.	Item	Function	Remarks
1	B-	Connect Battery Negative Electrode of the generator set starting	DC negative input
2	B+	When it is necessary to start the generator, connect battery charge positive electrode of the generator set starting	DC Positive Input (8~35V) for Controller Power Supply
3	Programmable output 1	Default #1 Switch off Output	Passive relay contact output, rated 7A
4			
5	Programmable output 2	Normal close	The default is generator startup, normal open output
6		Common terminal	
7		Normal open	
8	Programmable output 3	Normal close	Default ATSC Power A Phase Output
9		Common terminal	
10		Normal open	
11	Programmable output 4	Normal close	Default ATSC Power N Phase Output
12		Common terminal	
13		Normal open	
14	#1 closing output	Passive Relay Contact Output	Passive relay contact output, rated 16A
15	#2 closing output	Passive Relay Contact Output	Passive relay contact output, rated 16A
18	A1	#1 AC three-phase four-wire voltage input	For single-phase input, only A1 and N1 are accessed.
19	B1		
20	C1		
21	N1	#1 AC three-phase four-wire voltage input	For single-phase input, only A1 and N1 are accessed.
22	#1 closing input	Detecting the closing state of # II, auxiliary contact input:	Grounding connection is active
23	#2 closing input		
24	Programmable Input 1	User-defined function	Grounding connection is active
25	Programmable Input 2	User-defined function	Grounding connection is active
26	Common terminal	GND	
27	A2	#II AC three phase four wire voltage input	For single-phase input, only A2 and N2 are accessed.
28	B2		
29	C2		
30	N2		
31、32、33	A、B、GND	Standardized RS485 communication interface	

SKR2-B Controller Wiring diagram(1)

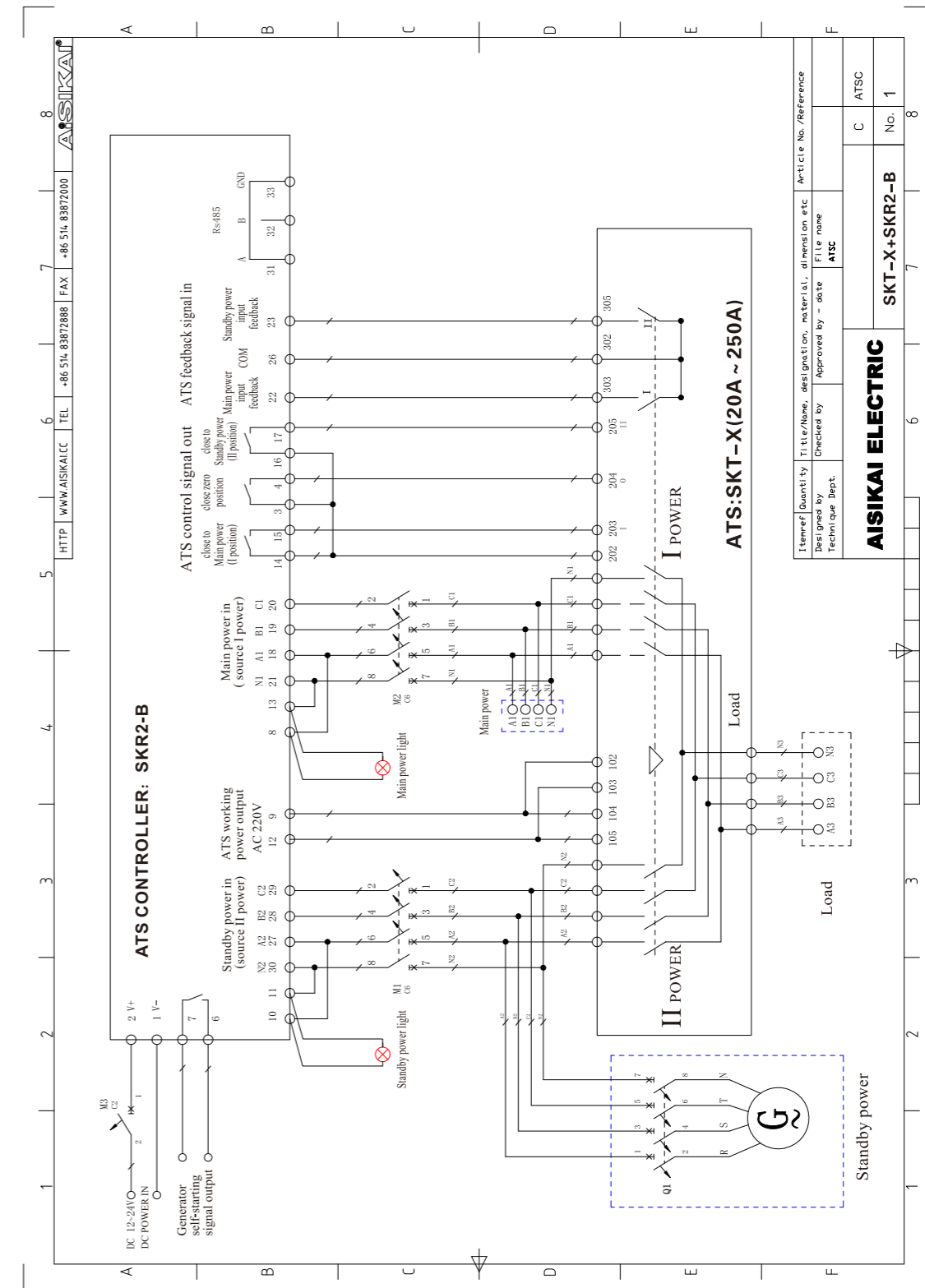

SKR2-B Controller Wiring diagram(2)

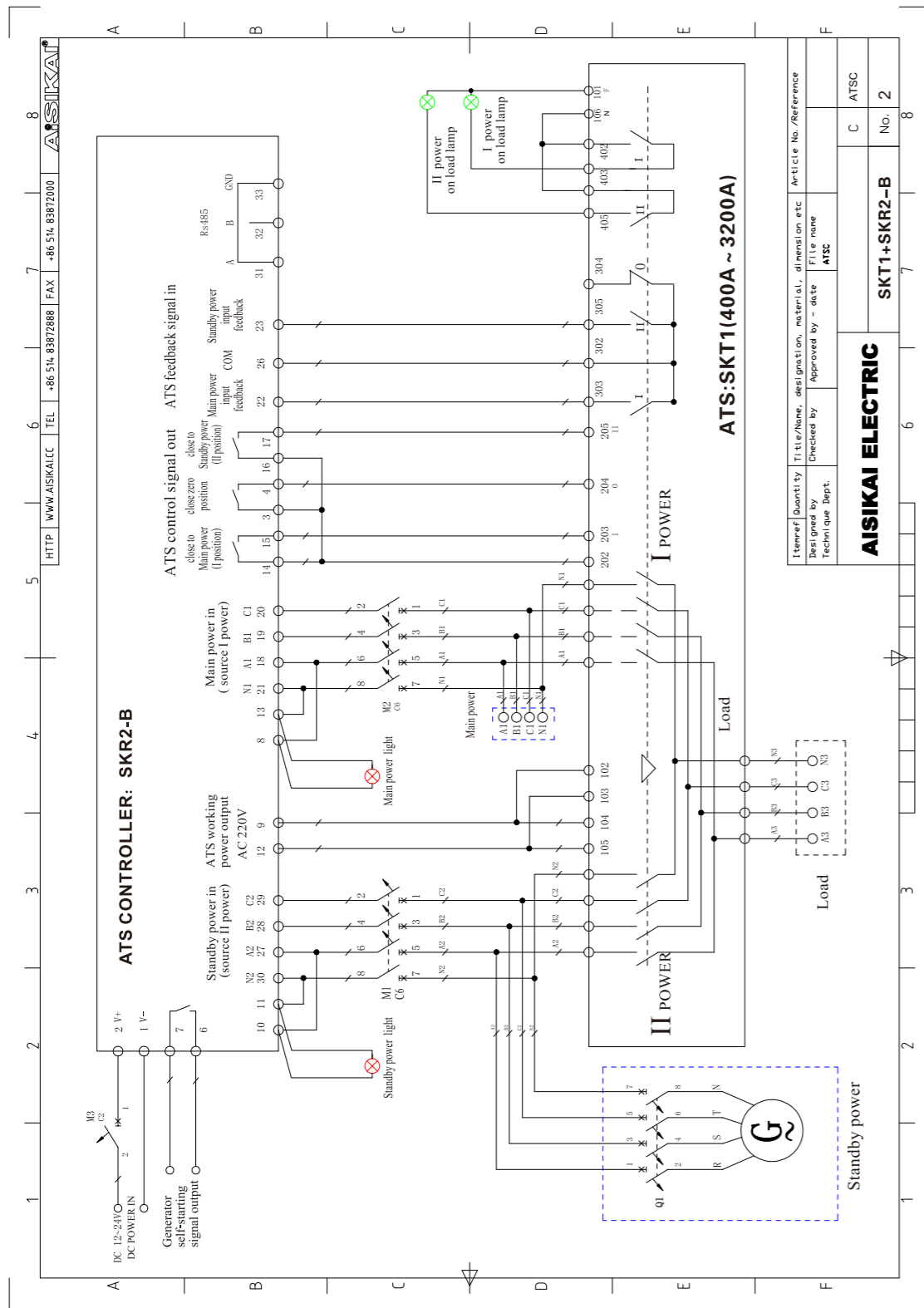

SKR2-B Controller Wiring diagram(3)

